

PRIMORDIA OF APRÈS-COUP, FRACTAL
MEMORY, AND HIDDEN LETTERS

Working the Exercises in Lacan's Seminar on "The Purloined Letter"

Appended to Lacan's "Seminar on "The Purloined Letter"" are three propaedeutics, "Presentation of the Suite," "Introduction," and "Parenthesis of Parentheses," collectively referred to as the *suite*, that elaborate a series of exercises intended to train the psychoanalyst somewhat in the manner of a cryptanalyst. The goal of these exercises, Lacan tells us, is for the student "to figure out how a formal language determines the subject"¹ in a symbolic chain that constitutes a form of remembering first discovered by Freud. Although Lacan assures us that his program is not intended to be difficult neither is it meant to be simple "since it assumes that a subject will not fulfill it except by contributing something of his own to it [*mettre du sien*],"² a requirement that is not always met by those addressing the suite. According to Bruce Fink, many readers find the suite distasteful because its diagrams and mathematical symbols hold little literary appeal;³ and, in the "Presentation of the Suite" (designed for those "who were leaving, having gotten a feel for my seminar"⁴), Lacan decries those who would dismiss his program out of hand with unfair accusations of intellectualization. This is not to mention the hackneyed legerdemain that Lydia H. Liu laments when writers fetishize Lacan's textual excursions into Poe's story "as a virtuoso performance in psychoanalytic criticism" that turns "that criticism into all kinds of navel gazing exercises," exercises that deflect attention away from those in the suite that explicate "his important discoveries concerning the Freudian unconscious."⁵ As Lacan indicates in the "Presentation of the Suite," the exercises are the seminar's centerpiece: the analysis of the "The Purloined Letter," "merely refines on the grace of one of those exercises."⁶

Although not intended to be difficult, Lacan's program is, nonetheless, risky business: to learn from it, a subject must wrestle with it, and the name one wins, in the end, may not prove flattering. Be that as it may, I have tried in this essay to take up Lacan's challenge and in struggling with the exercises to add something of my own to them. Bringing to bear in this endeavor a formal training in computer science, I have uncovered in Lacan's codes primordia of *après-coup*, fractal structures, and hidden letters buried in time, the excavation of which has deepened my understanding not only of how it is that a formal language determines the subject but also of what it means to engage Lacan's mathemes—the letters "from whence come the teaching of which I am the effect."⁷

The Exercises

The kernel of the suite is the “Introduction,” which, as already noted, Lacan presents “to give my audience practice in the notion of remembering implied by Freud’s work;” he goes on to reveal that “I did this due to the all-too-well-founded consideration that by leaving it implicit, the very basics of analysis remain fuzzy.”⁸ Prefacing the “Introduction” is the “Presentation of the Suite,” a polemic that was written to fend off detractors, those who “in explaining to themselves their everyday subject, their patient, as they say, or even explaining themselves to him . . . employ magical thinking.”⁹ This piece aims at knocking “the psychologist’s assurance down a notch”¹⁰ so that the patient can be heard “in the proper manner at the moment at which he speaks.”¹¹ Finally, the section entitled “Parenthesis of Parentheses” is a postscript that expounds a transcoding of symbols defined in the “Introduction” into binary digits and a set of parentheses that elucidate the L schema. This section also concludes the suite with an elaboration of Dupin’s exposition of the Even or Odd game—a game that becomes itself something like a closing parenthesis mirroring an opening parenthesis in the “Introduction” with Freud’s *Fort-Da* game.

In the game of Even or Odd, a player is asked to guess whether the number of marbles held in his competitor’s hands is even or odd. The supposed wizardry of the youth in Poe’s story (whose wins clean out the schoolyard) is revealed by Dupin to rely on an imaginary identification with the opponent, whom the child *becomes* by mirroring his mannerisms and facial expressions so as to listen within his own mind to his rival’s reasoning about the next guess—a process that Lacan points out leads to an indefinite oscillation.

The solitary *Fort-Da* game, played out by Freud’s eighteen-month-old grandson with a cotton reel, which he would repeatedly toss out of sight with the exclamation *Fort* and then reel back into view with a welcoming *Da*, marks for Lacan, in its enunciation of the phonemes of presence and absence, the “zero point of desire,” when the “human object comes under the sway of the grip which, canceling out its natural property, submits it henceforth to the symbol’s conditions.”¹² This is the point that sets in motion *repetition automatism* and the chaining of symbolic alternatives of presence and absence that aim at “*refinding an object that has been fundamentally lost* [italics in the original].”¹³

It is between these two children’s games, one that encodes and one that pretends to decode, that the exercises in the “Introduction”—their elaborations, loops, and cross-conjunctions—are worked out.

Exercise 1: Recording a Pattern of Presence and Absence

Mothers disappear. In his discussion of the *Fort-Da* game, Freud notes that his nephew was a normal boy who enjoyed a good rapport with his family, especially with his mother who tended him herself. Yet she would leave him, often for hours on end. This could not have been a pleasant experience for the boy, Freud tells us,

and her return must have been accompanied by the greatest of joy. The life of the infant is punctuated by experiences of mother's disappearance and reappearance and the consequences of unpleasure and pleasure. Hence, we begin our exercises, much like the infant, by recording a series of coin tosses with a plus and a minus sign connoting the "alternative of presence and absence."¹⁴

Though it might be presumed that heads connotes presence (and with its positive valence maps to plus) and that tails connotes absence (and with its negative valence maps to minus), no explicit key is provided. The significance of each sign lies solely in its relation to the other: what the one *is*, the other *is not*.¹⁵ Consequently, no definitive reconstruction of what took place is possible from such a record. Thus, from the start, there is no true or false; there is only the inscription of a pattern.

Exercise 2: Retracing the Record: Memory and the Emergence of Law

When it comes to a coin repeatedly flipped by human hand, the ensuing pattern of heads and tails is biased towards repeating the initial state of each flip. The result depends on a single parameter: the angle between the normal to the coin and the angular momentum vector. A magician knows how to keep this angle under forty-five degrees so the coin never flips though in its spinning it appears to do so. As Persi Diaconis, Susan Holmes, and Richard Montgomery put it, "coin-tossing is 'physics' not 'random.'"¹⁶ Following the lead of Freud, who argued that numbers picked at "random" are determined by unconscious thought,¹⁷ Lacan, both in the "Parenthesis of Parentheses" and in *Seminar II*, contends, in effect, that coin-tossing is "language" not "random." "No pure game of chance exists," he writes, for as soon as a person engages in guessing the result of a coin flip, "there is already the articulation of one word with another."¹⁸ Moreover, without the "sign" there is no outcome. Even when playing alone, "there is already the articulation of three signs, comprising a win or a loss, and this articulation prefigures the very meaning of the result;"¹⁹ thus, it is the symbol, not the subject, that organizes the result. The subject plays but a part in the game: "the role of the little *pluses* and *minuses* in it," thereby becoming "an element in this chain, which, *as soon as it is unwound* [emphasis added], organizes itself in accordance with laws."²⁰

In exercise 2, the record of presence and absence is retraced and encoded, with a loss of granularity, by viewing the series through a window the size of three signs that incrementally slides across the record one sign at a time, as illustrated in Figure 1. Grouping signs by three paves the way for ideas of symmetry (or evenness) and dissymmetry (or oddness) to emerge. The codes extracted from this window represent three categories of triples labeled 1, 2, and 3 and are so arranged that labels 1 and 3 contain symmetrical patterns, but of two different kinds, what Lacan calls the *symmetry of constancy*, represented by the triples [+++] and [---] and labeled 1, and the *symmetry of alternation*, represented by the triples [+--+] and [-+-] and labeled 3. In both cases, the two elements delimiting the triples match. In other words, codes 1 and 3 are made up of line

symmetric triples, with the line of symmetry drawn through the middle term. Category 2 is based on dissymmetry, revealed by the presence of an *odd* or dissimilar +/- member framing the triple, as exhibited in the remaining four possible permutations of three coin flips: [++-], [--+], [+--], and [-++]. With this definition of the three categories in mind, a record of tosses can be transcribed, as in Figure 1, as a series of numeric codes.

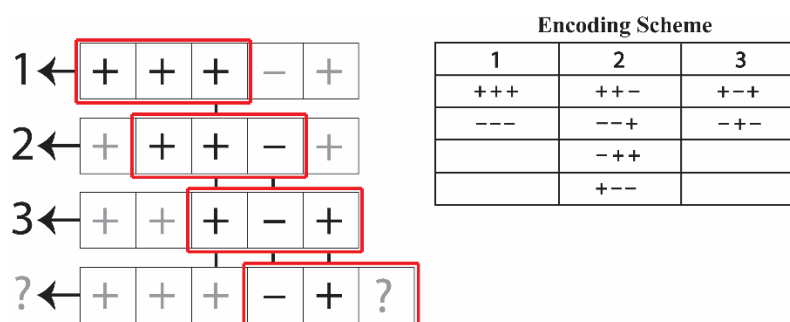

Figure 1. Example Numeric Encoding of a Record of Coin Tosses.

The sliding window analogy, provided for its simplicity and clarity, obscures a retrogressive step, however, in what is essentially a reductive process, that is, a form of *condensation*, where five signs in Figure 1, for instance, are rewritten as three. After isolating and encoding the first three +/- signs, another way of representing the encoding process would be to advance sign by sign, and, *looking backward*, to examine each sign in relation to the previous two, rewriting the group accordingly.²¹ This way of conceptualizing the transcoding process ties the formation of the numeric code to the mechanism of condensation as described by Freud in *Wit and Its Relation to the Unconscious*. In this text, Freud explores many forms of condensation in witticisms, one being the overlapping of letters between words. He illustrates this idea with such mixed word formations as *alcoholiday*, which compresses the last three letters of the word *alcohol* with the first three letters of the word *holiday*, noting that the effect of the witticism relies on a retrogression: the flickering double take of the syllable *hol*.

In addition to ideas of symmetry and dissymmetry, Lacan goes on to note that the numeric encoding scheme causes “possibilities and impossibilities of succession to appear,”²² that is, an unfolding of new layers of presence and absence and the laws governing this unfolding. Whereas any given plus or minus in a record of tosses is (ideally) independent, a specific numeric code in a sequence of such codes is always restricted by those that precede it. Examining the last item in Figure 1, for instance, it can be seen that only two of the three possible numeric codes can replace the question mark, either 2 (if the next sign is +) or 3 (if the next sign is

–); this is so because only these two numeric codes contain a triple that matches the initial pattern –+.

A law of succession is thus observed to emerge and that is that each plus/minus triple can link up with only two others, in this way producing either a numeric code that is the *same* as the one preceding it or one that is *different*. Another law of succession regulates the sequencing of symmetric codes: 3 cannot follow 1 (since no 1 ends with two dissimilar plus/minus signs), and 1 cannot follow 3 (since no 3 ends with two identical signs). In other words, any sequence connecting the two types of symmetries must be mediated by a dissymmetry.

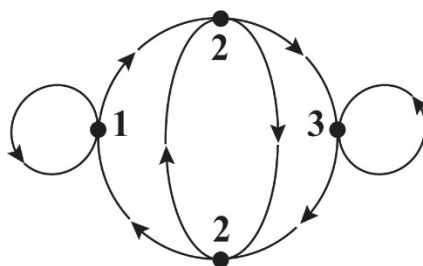

Figure 2. Lacan's 1-3 Network.

These laws of succession are described in Lacan's 1-3 Network,²³ reproduced in Figure 2, which traces all possible sequences of the numeric code. Readily observable in this graph are the cycles and loops that represent repetitions of the same code: 11^+ , 22^+ , and 33^+ (the superscript + is *Kleene plus* and means that there are one or more occurrences of the symbol preceding the operator²⁴). Careful examination of the numeric encoding scheme reveals that each of these cycles is uniquely generated by the plus/minus triples defining the repeating code. Whereas in a record of absence and presence, repetitions of the same sign (plus or minus) are always of the *same kind* (that is, ever indicating, regardless of sign, the successive appearance of the self-same side of a coin), 11^+ , 22^+ , and 33^+ differ, as we shall see, not only in the manner in which they govern the chain of signification but also in the manner in which they determine the reconstruction of possible toss records that informed the repetition of codes in the first place.

Bounding the 1-3 Network are the symmetric self-loops 11^+ and 33^+ , each behaving in accordance with its symmetric type. The constancy of 11^+ precludes any exchange in the loop between the two plus/minus triples ($[+++]$ and $[---]$) defining the 1 code. In other words, the pattern providing entry to the loop is the revolving door furnishing exit. The alternation inherent in 33^+ , however, claims the participation of both triples defining the 3 code ($[+-+]$ and $[-+-]$), with the two patterns serving equally as points of entrance and exit. Unlike 11^+ and 33^+ , the cycle described by 22^+ has the distinction of circulating between two separate

points (conjoining four triples), each marking the intersection of two divergent paths, the one bridging 1 to 3 (top) and branching directionally in and out of the 22^+ cycle and the other bridging 3 to 1 (bottom) and likewise offering access in and out of the 22^+ cycle.²⁵

Inspection of the 22^+ cycle reveals that the switching taking place at these two points is directed by triples partitioned into two sets: those that begin with identical signs and those that end with identical signs (see Table 1). These sets are mirror images of each other and express divergent (and directionally opposite) pathways of flow in the network. For ease in following the chain of signification that develops in exercise 3, these two sets will be distinguished, when necessary, by a circumflex ($\hat{2}$) and a caron ($\check{2}$), selected to correspond visually with the top and bottom vertices of the 22^+ cycle represented in the 1-3 Network. As already noted, without this split in the 2 code, no transit between 1 and 3 or between 3 and 1—that is, no walk through the outer circuit of the network interposed between the two symmetric self-loops—would be possible.

1 (even)	$\hat{2}$ (odd)	$\check{2}$ (odd)	3 (even)
[+++]	[++-]	[-++]	[+-+]
[---]	[- -+]	[+--]	[-+-]

Table 1. *Numeric Encoding with Division of Number 2.*

On the face of it, the four plus/minus encodings of 2 express four different pathways through the 1-3 Network and represent four possible reconstructions. Indeed, no matter the length of the numeric series, as long as it is defined as 22^+ there are always four possible reconstructions of the plus/minus record (the series [22], for example, encodes [++--], [--++], [-++-], and [+--+]). In contrast, 1 and 3 both express two different pathways through the network, and any numeric series of any length containing either 1 or 3, including 11^+ and 33^+ , encodes only two possible +/- records. What this means is that the introduction at any time of 1 or 3 in a series starting out as 22^+ *retroactively* redefines the decoding, or unwinding, of the memory trace by eliminating two possibilities. For instance, the addition of 1 in the series above to produce [221] immediately eliminates the last two plus/minus encodings of [22] since 1 must start with two identical signs. Thus, it can be said that the symmetric patterns determine the dissymmetric patterns. Although Lacan does not examine this aspect of determinism, we find already inherent in the numeric encoding of a pattern of presence and absence a rudimentary structure offering the possibility of retroaction.

The determinism of the symmetric over the dissymmetric takes yet another form, also related to memory, which Lacan does mention. Provided that a succession of 2s in a series is framed by either 1 or 3, these symmetric delimiters *remember*, as it were, whether the number of 2s contained therein is even or odd. If such a frame

is itself same/even,²⁶ that is [1-1] or [3-3], then the number of 2s inside is even, but if the frame is different/odd, that is [1-3] or [3-1], then the number inside is odd.²⁷ In this way, and “right from the primordial symbol’s first composition with itself . . . a structure, as transparent as it may still remain to its givens, brings out the essential link between memory and law.”²⁸

Exercise 3: The Exchange of Letters

The determinism uncovered in the numeric encoding scheme worked through in Lacan’s last lesson increases in complexity as more codes are generated by the iterative application of the same organizing principle. The next evolution in this iterative process encodes the legal succession of three numeric codes according to their +/– symmetric/dissymmetric (even/odd) designations. This produces four new codes, which Lacan labels α , when symmetry is joined to symmetry ([1.1], [3.3], [1.3], and [3.1]),²⁹ β when symmetry is joined to dissymmetry ([1.2] and [3.2]), γ when dissymmetry is joined to dissymmetry ([2.2]), and δ when dissymmetry is joined to symmetry ([2.1] and [2.3]).

Of the sixty-four possible combinations of numeric triples (considering the two different 2s),³⁰ only sixteen are legal, four of which fall into each of the four symmetrical/dissymmetrical categories of letters. Take, for example, the case of symmetry joined to symmetry or the letter α . Since 1 cannot directly connect to 3 or 3 to 1, the only numeric code that can replace the dot in [1.3] and [3.1] is 2. Likewise, the only code that can replace the dot in the other two possibilities for α , [1.1] and [3.3], is the repetition of the same number defining the frame, either 1 or 3, since a trail starting out from 1 or 3 and returning to itself again via 2 requires the intervention of at least one other 2 (an even number of 2s as noted in the last exercise) for a minimum sequence of four numeric codes, not three. Thus, the letter α is defined by these four triples: [123], [321], [111], and [333].

In Figure 3 the four numeric triples defining the letter codes are mapped out on the 1-3 Network. As can be observed, the first two triples include a cycle, and the last two triples define paths connecting three separate points, that is, three different numeric codes (if the top and bottom 2s in Lacan’s 1-3 Network are distinguished).³¹

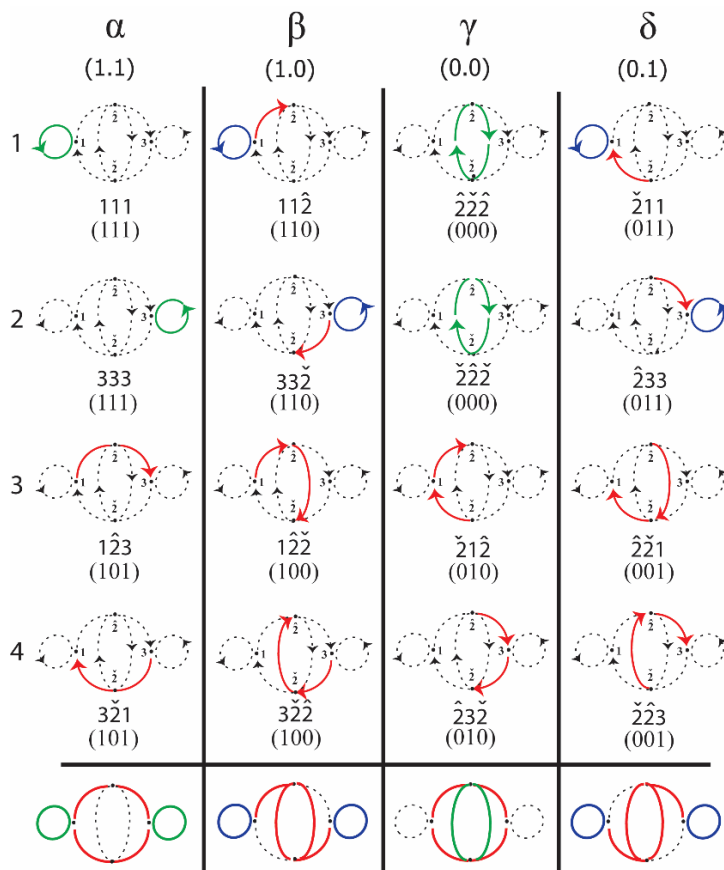

Figure 3. The Greek Letter Codes Mapped on the 1-3 Network. Note: in this figure the letters encoding legal numeric triples (as well as Lacan’s later binary codes,³² which are placed in parentheses) are superimposed on the 1-3 Network. The two points representing code 2 are distinguished with a circumflex ($\hat{2}$) and a caron ($\tilde{2}$), as defined in Table 1. The four permissible triples for each letter are numbered 1-4 on the left-hand side. Green trails are cycles that are traversed twice; blue trails are self-loops that are traversed once, and a red path connects two separate points.

The composites on the bottom row of Figure 3, which superimpose all trails produced by the four numeric triples defining each letter, visually highlight some marked similarities between the patterns composing, on the one hand, the pair α and γ and, on the other hand, the pair β and δ . Each of the α and γ composites circumscribes the larger circuit (in red) connecting the points $[1-\hat{2}]$, $[\hat{2}-3]$, $[3-\tilde{2}]$, and $[\tilde{2}-1]$ though they differ in the way the two semi-circles defined by triples three and four of each letter complete the circuit (horizontally for α and

vertically for γ). Another point of similarity between α and γ is the way in which the first two triples of the pair circumnavigate cycles (in green) twice, producing a superimposition that either traces out the symmetric self-loops ([111] and [333]) in the case of α or variations of the dissymmetric numeric cycle ([222]) in the case of γ . In contrast, the composites of β and δ trace out all three numeric cycles; but, unlike α and γ , the first two triples defining β and δ are limited in circumscribing the symmetric self-loops (in blue), making only one round after entering the loop in the case of δ and only one before exiting the loop in the case of β , a variation that produces superimpositions that are mirror images of each other. Later, Lacan transcodes this mirroring pair into a set of parentheses.

The laws of consecutive letter succession that emerge from this encoding scheme are entirely determined by the trails these sixteen numeric triples map on the 1-3 Network. The α and γ pair, for instance, whose first two triples are observed to loop twice, are able, as Lacan notes, to “overrun the entire chain”³³ if caught in a self-loop generating endless strings of $\alpha\alpha^+$ and $\gamma\gamma^+$. Closer inspection shows that these two self-loops behave on one level in a manner identical to the numeric self-loops, with the α self-loop following the law of constancy and the γ self-loop following the law of alternation. As was the case with the plus/minus sequences propagating 11^+ , a given sequence of $\alpha\alpha^+$ is always generated by the same underlying code, in this case either $\alpha 1$ or $\alpha 2$ (representing, as detailed in Figure 3, the numeric triples [111] and [333], respectively). In other words, the triple providing entry into the α self-loop is the same one furnishing exit. Likewise, in following the law of alternation, the $\gamma\gamma^+$ sequence requires the participation of both the $\gamma 1$ and $\gamma 2$ ([222] and [222]) cycles. That the laws of constancy and alternation govern the production of $\alpha\alpha^+$ and $\gamma\gamma^+$ can be verified visually by consulting Figure 4, which traces in detail all possible sequences of the letter encoding scheme.

As dictated by the first two triples defining β and δ , which loop only once, the β and δ self-loops permit just one revolution through the loop (see Figure 4), prohibiting, as a consequence, the sequences $\beta\beta\beta^+$ and $\delta\delta\delta^+$. However, since both β and δ are interconnected in the manner indicated by their mirroring composites, each letter can exit its own self-loop to transition into the self-loop of the other, possibly cycling this way forever. Potential infinite cycles also exist between the letters α and γ (though not between their respective self-loops as is the case with β and δ), making possible an infinite series of $(\alpha\gamma)^+$ and $(\gamma\alpha)^+$. Repeated cycles do not exist between α and β ; α and δ ; β and γ ; γ and δ .³⁴

Lacan has much to say about these cycles and loops. He notes, for example, that whereas α and γ could potentially overrun a chain of letters in infinite self-looping, the only cycling possible between the self-loops of β and δ —defined as either $(\beta\beta\delta\delta)^+$ or $(\delta\delta\beta\beta)^+$ —“limits to 50% the maximum possible frequency of each of them.”³⁵ Given that the probability of a “fair” coin toss is 0.5, Lacan sees these differences in the mechanisms governing the cycling of letters as separating “out from the real a symbolic determination which, as faithful as it may be in recording

any partiality of the real, merely produces all the more clearly the disparities that it brings with it.”³⁶

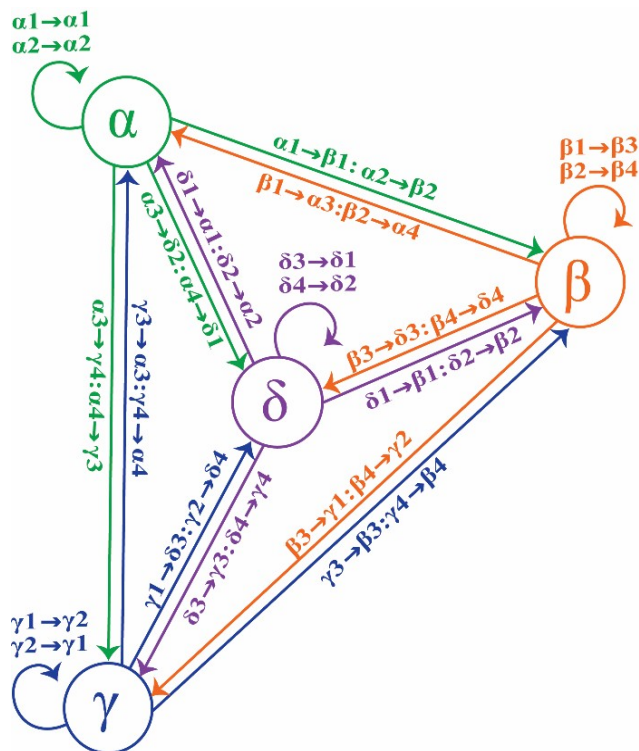

Figure 4. Transition Diagram of Letter Codes. Note: the paths emerging from the letters are color-coded for ease of identification. The symbol \rightarrow placed between two letter codes means that the code before the symbol “transitions to” the code following the symbol. The numbers that follow each letter represent the four numeric triples defined in the far left-hand side of Figure 3.³⁷ Thus, for example, $\beta 2 \rightarrow \alpha 4$, means (consulting Figure 3) that $[33\check{2}]$ transitions to $[3\check{2}1]$ producing the permissible sequence $\beta\alpha$ (permissible because the last two numbers of $\beta 2$, that is, $[3\check{2}]$, match the first two numbers of $\alpha 4$).

Even more interesting is the meaning Lacan attributes to these cycles, particularly when discussing the L Chain in “Parenthesis of Parentheses,” which he relates to the L schema presented at the end of the “Introduction.” Briefly, the double-looped $\beta\delta\delta\beta$ cycle is said to “cover” the structure of the subject,³⁸ that is, S, “the subject of the psychoanalytic session.”³⁹ Inside this structure, repetitions of γ stand for the “silence of the drives,”⁴⁰ with γ itself, when combined with α in any of their potential cycling, representing a punctuation of scansion. Cycles of $(\gamma\alpha)^+$ and $(\alpha\gamma)^+$

reflect the axis of the imaginary relation in the L schema, which is “the couple involved in reciprocal imaginary objectification.”⁴¹ Surrounding the $\beta\beta\delta\delta$ structure, in the field of the Other (A in the L schema), are repetitions of α (especially the $\alpha 1$ loop of unary symmetry), which Lacan says are “the times marked by the symbolic as such.”⁴² Also situated in this field, but encased within β - δ integuments, is the potentially endless cycle of $(\alpha\gamma)^+$, which Lacan identifies with the “ego of the psychological *cogito*—the false *cogito*—which can just as well prop up perversion pure and simple.”⁴³ We shall return to the L schema and its connection to the letter code later in our investigation.

For now, there is more that the cycling behaviors of the letters can teach us about the mechanism of letter code succession (and, by extension, memory and *repetition automatism*). As already mentioned, α and γ (unlike β and δ) never directly transition into each other’s self-loops. The two numeric triples defining the α self-loop ($\alpha 1$ and $\alpha 2$) either return to α or branch off to β . Similarly, the triples defining the γ self-loop ($\gamma 1$ and $\gamma 2$) either remain with γ or join up with δ . In other words, the triples defining the α and γ self-loops are *cut off* from each other. As a consequence, sequences such as $\gamma\alpha\alpha$ and $\alpha\gamma\gamma$ that directly connect γ and α to the other’s self-loop are simply not possible.

What is happening here provides a clue to the connective functioning of each letter code. Inspection of Figures 3 and 4 shows that every letter is partitioned into two parts (henceforth referred to as *moieties*), based on a division that has already been discussed between the first two numeric triples defining a letter that inscribe a cycle and the last two that bridge three points. Lacan also recognizes these moieties, which he labels with binary codes in his α , β , γ , δ Network.⁴⁴ Except for the special nature of the α and γ loops, triples 1 and 2 of each letter can be observed to flow together as a pair through the transition diagram in Figure 4, as do triples 3 and 4. Moreover, each pair is isolated from the other pair, *making every letter the site of two separate and opposite exchanges*. Thus, the succession of letters is determined by the connections their moieties make, a single moiety behaving something like a switch linking two that precede to two that follow, the two that precede functioning as parameters or inputs that regulate the outputs. What results is an elaborate reformulation of the pattern of presence and absence, where every moiety both activates or permits four sequences of three-letter codes and suppresses or prohibits four others.

All sixty-four combinations of three-letter codes, whether permitted or not, are listed in Figure 5 beneath an illustration of the eight moieties and their inputs and outputs. With the exception of γ , the cycling 1 and 2 (abbreviated 12 and read as “one two”) numeric triples defining the letters (see Figure 3) constitute one group (category 1), and the bridging 3 and 4 (abbreviated 34 and read as “three four”) triples comprise another (category 0). The four moieties in category 1 permit all three-letter sequences beginning with α and δ and ending with α and β but filter out those ending in γ and δ . Similarly, category 0 moieties permit all three-letter sequences beginning with β and γ and ending in γ and δ but filter out those ending in α and β .

Category 1

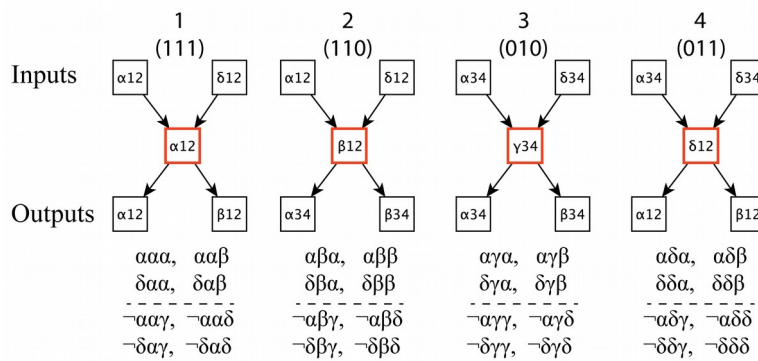

Category 0

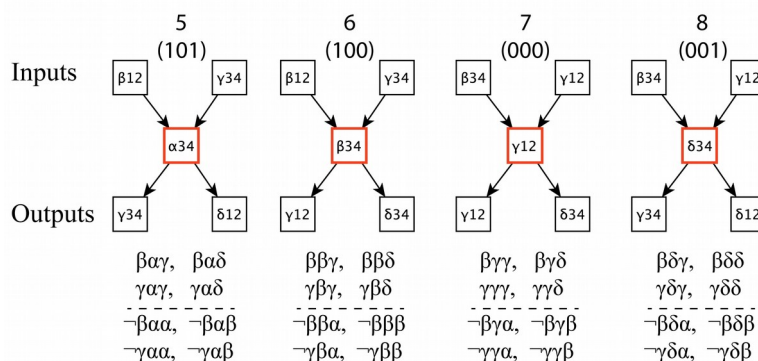

Figure 5. Inputs and Outputs of the Eight Moieties. Note: each of the eight moieties (located in the center of each network and outlined in red) permits and prohibits four three-letter sequences. These sequences are listed below the networks (the ‘-’ sign means ‘not’ and is applied to those sequences that are excluded by the moiety and impossible within the language of the letter code). Lacan’s binary designations for the eight moieties are in parentheses,⁴⁵ and the two categories are labeled based on the middle binary term that differentiates the two groups (binary 1 representing the symmetric/cycling moieties and binary 0 the dissymmetric/branching group, with γ moieties the interlocking exception).

Lacan summarizes the permissible three-letter sequences in his Δ Distribution⁴⁶ diagram, which lists all possible letter successions at times one, two, and three. Reflecting on the links forged between exclusive pairs of letters at times one and three (which comprise the inputs and outputs of the two categories of moieties), he concludes that time three is “the constitutive time of the binary,”⁴⁷ which indeed it is. As our analysis has demonstrated, every letter is divided into two, its moieties belonging to two different categories that share two possible inputs and two possible outputs. Lacan comments later on that “The fact that the link has

appeared here is nothing less than the simplest formalization of exchange and is what confirms for us its anthropological interest.⁴⁸ Certainly, we have discovered within this simple language the emergence at time three of a system of rules that, determined by binary oppositions and mediated by groups of three, govern not only what can be exchanged but also what is prohibited.⁴⁹

Lacan’s interest in what is prohibited, however, is focused more on what happens when a fourth term is added to the permitted sequences of three letters. In this case, we find all sixty-four *permissible* four-letter sequences organizing themselves into quadrants of sixteen each that are determined by a letter that is excluded at both times two and three, as well as by a shared additional missing letter at time two and yet another at time three, for a total of three missing letters. Lacan organizes all permissible four-letter sequences into their respective quadrants (defined by the missing letters) in his Tables Ω and O,⁵⁰ reproduced as Figure 6 with quadrants marked.

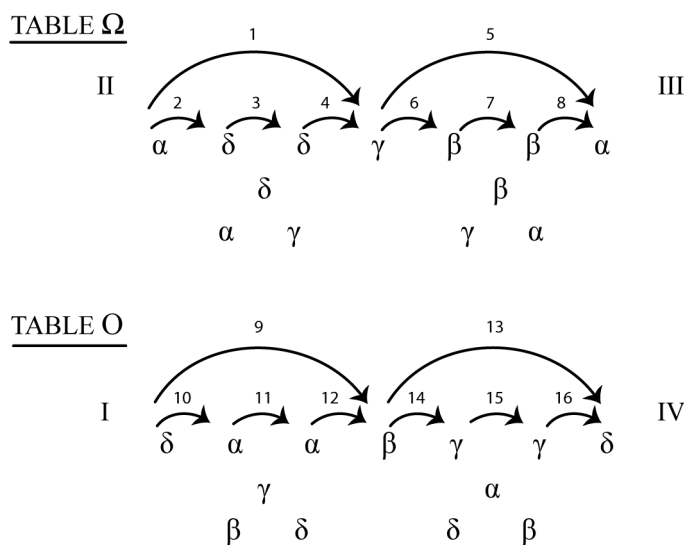

Figure 6. Tables Ω and O Labeled with Quadrants (Roman Numerals) and Figure A1.1 Tree Numbers.⁵¹ Note: an arc represents a skip from letter one to letter four and thus four sequences of length four. The letters arranged in a pyramid beneath the quadrants represent the shared missing letter at times two and three (top) and the additional missing letter at time two (bottom left) and at time three (bottom right).⁵²

Lacan suggests that what we have here at time four is a possible “rudimentary subjective trajectory, by showing that it is grounded in the actuality which has the future anterior in its present.”⁵³ We do indeed discover at time four a trajectory that convolves past, present, and future—this convolution the effect of the

impossibilities Tables Ω and O are meant to illuminate, where each of the quadrants are defined by three missing letters: those at time two plus those at time three, the missing letters at times two and three having been removed retroactively, as we shall demonstrate, at time four. Lacan goes on to say that “in the interval of this past that is already insofar as it projects, a hole opens up that is constituted by a certain *caput mortuum* of the signifier (which is set here at three-quarters of the possible combinations in which it must situate itself), suffices to make it depend on absence, obliging it to repeat its contour.”⁵⁴

Setting aside the total number of missing letters at times two and three and the contours of absence these inscribe within four-letter sequences, Lacan may also be referring here to the fact that the sequences situated in each quadrant are quarantined from the remaining three, the missing letters appearing at this juncture to limit any further intermingling between quadrants. This speculation, though unlikely, would nonetheless explain why Lacan discontinued his analysis of the letter code at time four.⁵⁵ That he stopped short where he did is perplexing⁵⁶ (however much this serves to illuminate his theory of scansion) considering that future sequences, as we shall see, are not bound by the contours of absence established at time four; rather, four-letter sequences, with their retroactive pruning of letters at times two and three, foreshadow yet another *caput mortuum* of the signifier, one giving rise to yet another pattern of absence, inaugurated at time five by a breach between quadrants that erects within each one (and *ex post factum* at time three) a single signifier.

An appreciation of these (de)materializations within the letter code, however, requires a more in-depth analysis, which is provided in Appendix 1. The results of this analysis are summarized in Table 2, which reveals the general pattern of letter succession for each of the quadrants, the patterns differing from one another in detail only and not in form. It will be observed that the first and last letters of a sequence of four or more letters serve as a set of coordinates that situates each sequence within one of the quadrants (which are not defined until time four when the first “*caput mortuum* of the signifier” and retroactive pruning of letters are encountered). A stable pattern of letter succession only becomes evident, however, much later at time six. The basic pattern established from this point forward is clearly defined by two moieties: one situated at the start of the sequence (time two) and one located at the end (in the penultimate position). These bounding moieties belong to specific categories defined by the quadrant coordinates (that is, by the inputs and outputs of the bounding moieties). Referring to Table 2, for example, we find that Quadrant I is bounded by category 1 moieties, whereas Quadrant II starts off with those in category 1 and terminates with those in category 0, and so on, with none of the bounding pairs duplicated in another quadrant.⁵⁷ Careful inspection of the two odd patterns produced by four-letter and five-letter sequences reveals that they too follow the same general pattern but become *deformed* as a result of a collision between the inputs and outputs of the moieties framing the sequence, a collision that retroactively eliminates more letters—most strikingly in the case of five-letter sequences, where at time three a total of three letters fall out with the imposition of the terminating moiety.

Time (t)	Quadrant I (α)					Quadrant II (β)				
	1-4	1-5	1-6	1-7	1-n	1-4	1-5	1-6	1-7	1-n
1	α, δ	α, δ	α, δ	α, δ	α, δ	α, δ	α, δ	α, δ	α, δ	α, δ
2	α, δ	1	1	1	1	γ, β	1	1	1	1
3	α, β	α	α, β	α, β	α, β	α, β	β	α, β	α, β	α, β
4 (...)	α, β	1	α, δ	all	all	δ, γ	0	γ, β	all	all
5 (t-3)		α, β	1	α, δ	(...)		δ, γ	0	γ, β	(...)
6 (t-2)			α, β	1	α, δ			δ, γ	0	γ, β
7 (t-1)				α, β	1				δ, γ	0
t=n					α, β					δ, γ

Time (t)	Quadrant III (δ)					Quadrant IV (γ)				
	1-4	1-5	1-6	1-7	1-n	1-4	1-5	1-6	1-7	1-n
1	β, γ	β, γ	β, γ	β, γ	β, γ	β, γ	β, γ	β, γ	β, γ	β, γ
2	α, δ	0	0	0	0	γ, β	0	0	0	0
3	γ, δ	δ	γ, δ	γ, δ	γ, δ	γ, δ	γ	γ, δ	γ, δ	γ, δ
4 (...)	α, β	1	α, δ	all	all	δ, γ	0	γ, β	all	all
5 (t-3)		α, β	1	α, δ	(...)		δ, γ	0	γ, β	(...)
6 (t-2)			α, β	1	α, δ			δ, γ	0	γ, β
7 (t-1)				α, β	1				δ, γ	0
t=n					α, β					δ, γ

Table 2. Pattern of Letter Succession. Note: rows represent a time step (t), and columns represent sequences of different lengths, starting with four-letter sequences, the length at which quadrants are defined. The numbers 0 and 1 are moiety category numbers meaning that all four moieties in that category are possible at that particular time step for that given length.

The exclusion of all letters save one at time three holds for all five-letter sequences, the letter prevailing determined by the coordinates of the first and last letters of the string (its quadrant position) and revealed only from the standpoint of five-letter sequences. Though it is the case that the missing letters at times two and three in four-letter sequences (for Quadrant III, that would be α , β , and γ)⁵⁸ seem to converge in dropping out at time three in five-letter sequences, of the two letters that would otherwise occupy the third position (see Table 2), only one is

eclipsed, forgotten, repressed—retroactively by the addition of the fifth letter—while the other lays claim to the quadrant. Whereas four-letter sequences are directed at every time step by dyadic relations, time five marks the juncture where chains are determined by the ascendancy of one signifier, a sovereignty that ruptures the quadrant, setting into motion the construction of a vast expanse of chains that intertwine the quadrant of the letter that prevailed with the quadrant incarnating the letter that was dislodged.

How is it that the emergence of the single letters marks the time when quadrants are ruptured and patterns of displacement are instituted? If we write out all five-letter sequences that begin, for example, with the letter α , restricting our consideration for the moment to $\alpha 12$ (see Figure 7), we discover that half the sequences start out in Quadrant I and half in Quadrant II and that they remain in their starting quadrants until time five, when fifty percent of the sequences at this time step are displaced into the opposite quadrant. The reason for this displacement has to do with a shift in moiety categories that is instigated by the letter that will be eclipsed. For example, focusing on time three in Quadrant I, we find that fifty percent of the moieties are $\beta 12$, which only outputs $\alpha 34$ and $\beta 34$. If these sequences were to terminate at time four, they would be located in Quadrant I, but as soon as a fifth letter is added, the category 0 representations of α and β output only γ and δ letters, thereby displacing these sequences from Quadrant I to Quadrant II. A similar investigation of the other seven moieties reveals a pattern similar to the one displayed in Figure 7, the main difference being the letter inaugurating the displacement (which is the missing letter at time three) and the column locations of the transitions at time five.⁵⁹

	Quadrant I (α)								Quadrant II (β)							
Time 1	$\alpha 12$	$\alpha 12$	$\alpha 12$	$\alpha 12$	$\alpha 12$	$\alpha 12$	$\alpha 12$	$\alpha 12$	$\alpha 12$	$\alpha 12$	$\alpha 12$	$\alpha 12$	$\alpha 12$	$\alpha 12$	$\alpha 12$	$\alpha 12$
Time 2	$\alpha 12$	$\alpha 12$	$\alpha 12$	$\alpha 12$	$\alpha 12$	$\alpha 12$	$\alpha 12$	$\alpha 12$	$\beta 12$	$\beta 12$	$\beta 12$	$\beta 12$	$\beta 12$	$\beta 12$	$\beta 12$	$\beta 12$
Time 3	$\alpha 12$	$\alpha 12$	$\alpha 12$	$\alpha 12$	$\beta 12$	$\beta 12$	$\beta 12$	$\beta 12$	$\alpha 34$	$\alpha 34$	$\alpha 34$	$\alpha 34$	$\beta 34$	$\beta 34$	$\beta 34$	$\beta 34$
Time 4	$\alpha 12$	$\alpha 12$	$\beta 12$	$\beta 12$	$\alpha 34$	$\alpha 34$	$\beta 34$	$\beta 34$	$\gamma 34$	$\gamma 34$	$\delta 12$	$\delta 12$	$\gamma 12$	$\gamma 12$	$\delta 34$	$\delta 34$
Time 5	$\alpha 12$	$\beta 12$	$\alpha 34$	$\beta 34$	$\gamma 34$	$\delta 12$	$\gamma 12$	$\delta 34$	$\alpha 34$	$\beta 34$	$\alpha 12$	$\alpha 12$	$\gamma 12$	$\delta 34$	$\gamma 34$	$\delta 12$

Figure 7. All Five-Letter Sequences Starting with the $\alpha 12$ Moiety and Illustration of Quadrant Displacement at Time Five. Note: the displacement is initiated at time three by the letter naming the associated quadrant (outlined in red).

As more letters are added, half the outputs of the moieties in the penultimate position in the previous time step become inputs to moieties in the opposite category, which displaces sequences two time steps later into the other quadrant (this explains why there are always only two possible letters in the antepenult position for strings greater than size five: when a sequence halts, the imposition of

the final moiety *always* retroactively removes two letters in the antepenult position). Once in this second quadrant and for as long as the sequence continues, half the moieties in the penultimate position of these displaced codes flip the sequence back two time steps later to its quadrant of origin, repeating (remembering) in this way the earliest inscriptions of presence and absence.

Not all sequences in a quadrant suffer (and thus record within themselves) moments of displacement. Tallying up the four sequences that remain in Quadrant I for all moieties initially positioned in this quadrant (α_{12} , α_{34} , δ_{12} , and δ_{34}),⁶⁰ brings the total number of these “pure” sequences at time five to sixteen (four moieties \times four sequences), and this is the number that remains within every quadrant, no matter the number of letters appended.⁶¹

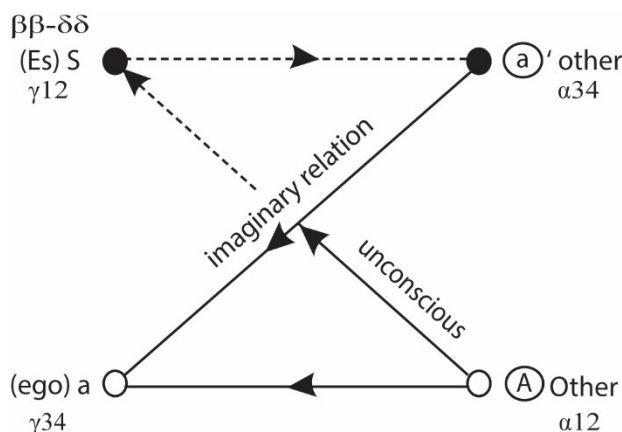

Figure 8. *L Schema with Associated Moieties*

The example of α_{12} in Figure 7 was chosen because of Lacan’s association in “Parenthesis of Parentheses” of the α self-loop with A in the L schema (see Figure 8). In the L Chain language, this loop stands outside the “quotes,” the sobriquet Lacan gives the basic $\beta\beta\delta\delta$ structure of the subject, so called because of the double quotes’ resemblance to nested parentheses, the opening and closing of which replace all instances of β and δ in the L Chain language (see Appendix 2 for a formal definition of the L Chain language and its five rules). It goes without saying that the α_{12} loop generates a pure sequence that remains within its quadrant, the γ_{12} loop being yet another, and one that Lacan places inside the double quotes that cover the structure of S (as well as inside any number of β and δ integuments within the quotes). The remaining fourteen pure codes are essentially α_{12} and γ_{12} loops with the addition of one to three letter prefixes (see Appendix 3) that serve to situate the loops within their quadrants and one to two

letter suffixes that set sequences up to be displaced later as they duplicate and grow in length into their complementary quadrants (thereby generating a series of new mixed sequences).⁶²

It is by means of these suffixes that A (α^+) and S (γ^+) on the symbolic axis cross over to the imaginary axis, much as is illustrated by the two directed arcs between S and a' and A and a in the L schema. The cycles $(\alpha\gamma)^+$ and $(\gamma\alpha)^+$ that represent for Lacan "the couple involved in reciprocal imaginary objectification"⁶³ are embedded in strings that, in effect, disrupt the pure codes and assume the iterative functioning of the α 12 and γ 12 loops. These disruptions are expressed in the L Chain language in the alternations of α 34 and γ 34 (and visa versa) that are played out between the linings of the double quotes (β - β and δ - δ)⁶⁴ or, in the exclusive case of the $(\alpha\gamma)^+$ cycle, outside the quotes in the "field of the Other (A in the L schema),"⁶⁵ where they lodge within β - δ shells, representing the "ego of the psychological *cogito*."⁶⁶ According to Lacan, these codes formulate "a certain remembering [*mémoration*] related to the symbolic chain," whose law "is essentially defined by the relay constituted," in the $(\alpha\gamma)^+$ and $(\gamma\alpha)^+$ cycles, "by the surmounting [*franchissement*] of one or several parenthetical signs [β or δ] and of which signs."⁶⁷

Not until the final sentence of the "Introduction" does Lacan connect the L schema to the letter code: "The similarity between the relationship among the terms of the L schema and the relationship that unites the four times distinguished above (in the oriented series in which we see the first finished form of the symbolic chain) cannot fail to strike one as soon as one considers the connection between them."⁶⁸ In Lacan's clarification of this connection in the section that follows in the seminar, it is interesting to note that "the relationship that unites the four times distinguished above" (if I may interpret this clause as referring to more than the quaternary structure exhibited in the combined Ω and O tables so as to encompass the specific terms contained therein as well), spells out in reverse in Table Ω the basic L Chain codes belonging to the symbolic axis: $\alpha\delta\delta\gamma\beta\beta\alpha$; moreover, the jumps over the β s and δ s (the surmounting of parenthetical signs), from the first to the middle term and from the middle term to the last, spell out the imaginary relation: $\alpha\gamma$ and its inverse $\gamma\alpha$.⁶⁹

The correspondence between the letter code and the L schema is carefully worked out by Lacan with his later addition of "Parenthesis of Parentheses," where the description of the L Chain language (as illustrated by the L Chain sequence) is centered on securing to its foundational four letter $\beta\beta\delta\delta$ structure not only the pure phrases positioned at the poles of the symbolic axis but also the interruptive displacement patterns (the wall of language) generated by the "imaginary grill," as well as by the outlying "false *cogito*." Because the $\beta\beta\delta\delta$ structure harbors within itself both the γ 12 loop on the symbolic axis and the imaginary α 34 and γ 34 cycle, the graph as a whole could well be viewed as "double" quoted. In Appendix 2, I make explicit some additional connections between the L schema and the L Chain language, tying both, in Appendix 5, to Lacan's α , β , γ , δ Network (which, like Figure 4, completely expresses the letter code).

By way of concluding the third exercise, it is worthwhile taking a moment to examine the composition of these displacement patterns since they shed light on the “entire appearance of remembering” in the “ordered chains of a formal language,” which is the kind of remembering that accounts “for Freud’s notion of the indestructibility of what his unconscious preserves.”⁷⁰ We can visualize this “appearance of remembering” in the letter code by mapping out the quadrant locations of sequences at each time step for larger numbers of terms, as in Figure 9, which illustrates these patterns for α and β moieties for ten time steps. Since the γ and δ patterns are identical in appearance to those for α and β , they are not shown.⁷¹

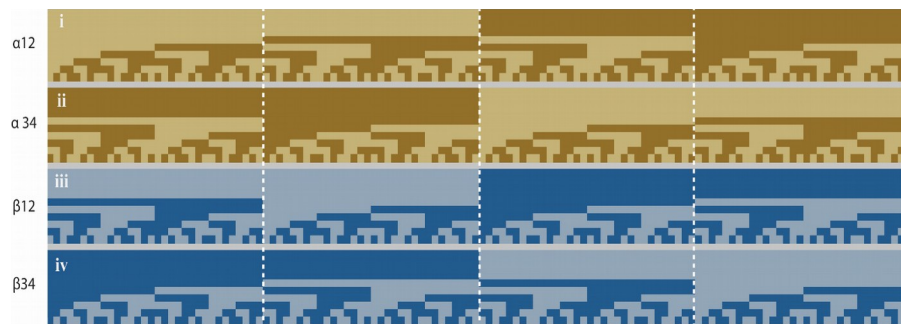

Figure 9. All α and β Moieties Color-Coded Based on Quadrant Locations for Strings of Length Ten.⁷² Note: each of the four images (α_{12} , α_{34} , β_{12} , β_{34}) shows a total of 512 sequences by ten time steps (time one at top and time ten at bottom). Every term (moiety/letter) in a sequence is represented by a small rectangle that is colored based on the quadrant it belongs to at each time step. As quadrants are not defined until time four, the first four terms are colored according to the quadrant defined at time four. Light brown represents Quadrant I, dark brown Quadrant II, light blue Quadrant III, and dark blue Quadrant IV. Roman numerals label the four basic patterns discernable within the images.

Examining Figure 9 we discover that the displacement images are composed of at least four distinct patterns (identified in the first column with Roman numerals) that are shuffled in each image.⁷³ The sequence of patterns in the α_{12} image, for example, is one, three, two, and four, whereas in the β_{34} image, the sequence, starting off with pattern four, is reversed. Closer inspection reveals that the four patterns can be grouped into pairs that are inverses of each other: pattern one is the inverse of four, and pattern two is the inverse of three. These patterns are, in fact, inverses of each other in terms of the moieties that make up the patterns, as explained further in Appendix 4. For instance, if a particular pattern has α_{12} (Lacan’s binary label 111) in a certain position, the inverse of that same pattern will have γ_{12} (binary label 000) in the corresponding position. Consequently, given the differential already discussed in letter probabilities, an inversion reveals a shift in α and γ dominance, with lighter patterns dominated by α and darker patterns by γ .⁷⁴

It will be observed that the patterns in Figure 9 are fractals, with smaller versions of the four patterns embedded within larger patterns, as illustrated more clearly in Figures 10 and 11. In other words, Lacan's letter code generates patterns of connectivity that are self-similar and typical of those formed by substitution systems that replace elements according to a set of rules, arranged, as in this case, such that larger sequences are subdivided into smaller sequences.⁷⁵

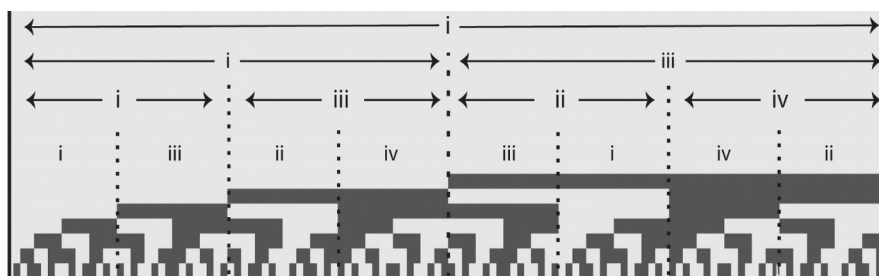

Figure 10. Fractal Fragment of the Image for α_{12} of Length Eighteen. Note: this pattern is formed by the first 512 (out of 131,072) combinations of eighteen letter sequences. In other words, this is $1/256$ of the entire image. Not all the fractal patterns visible in the image are labeled. Time one is at the top.



Figure 11. Another Tiny Fragment of the Image for α_{12} of Length Eighteen. Note: this fragment shows traces (top half) of much larger (elongated) displacement patterns.

With the analysis of the letter code completed as far as it will be taken in this essay, let us revisit the L schema once again, this time considering its connection to the letter code in light of the displacement patterns that have now been uncovered. The two poles of the symbolic axis, as already established, are linked to the two self-loops: γ_{12} or the drives, which we are told by Freud have no aim, no goal other than to loop,⁷⁶ and α_{12} , especially α_1 , the unary trait “by which repetition is marked as such,” a mark to which one can return, “which precisely is the unary trait.”⁷⁷ These two iterative engines do more, however, than self-loop: each is also capable of spinning off into the imaginary axis (in this sense, generating it)⁷⁸ via suffixes (parenthetical signs) that transport, on the one hand, γ_{12} to α_{34} —a point in the chain that marks a displacement between quadrants, a

displacement that is reflected in the L schema in a crossing over (*franchissement*) from the left-hand side of the subject/ego to the right-hand side of the other/Other—and, on the other hand, α_{12} to γ_{34} —marking yet another displacement between quadrants that is reflected in a crossing over from the side of the other/Other to that of the Subject/ego. As mentioned above, the displacement patterns in Quadrants II and IV are driven by the γ_{12} iterative engine and those in Quadrants I and III by the α_{12} engine, each the inverse of the other (see Appendices 3 and 4). Quarantined as they are within their separate domains, it is impossible for pure codes composed of only α_{12} or γ_{12} strings to cross paths—for them to reside in the same quadrants, except insofar as they are *projected* in expressions forged (via their prefixes and suffixes) within the vast wall of language, patterning it with their inversions.

Exercise 4: The Symbolic Circuit

Although it is the case that Lacan's suite contains difficult material, elliptical and cryptic in presentation, it is nonetheless perplexing that so few have attempted a full explication of it, especially of the three exercises. Much has been written about the L schema and its various incarnations, as well as Lacan's later algebraic expressions and topological figures, all of which exhibit difficulties of their own—so saying the exercises are neglected because the material is too dry or too mathematical or too complex is probably not the whole story. Despite being a project that was taken up and revised by Lacan on several occasions and granted a certain pride of place in his *Écrits*, this program was eventually dropped in favor of his more extensive modeling excursions into graphs, mathemes, and topology. Thus, the exercises represent an oddity, and it is Lacan's more characteristic modeling endeavors that his students have found more attractive.

The exercises are odd in yet another sense having to do with computing and cybernetics. According to John Johnston,⁷⁹ Lacan's discourse, at least in the 1954-5 seminar, which first presented the exercises, participates in a new discourse network, one that emerged after the Second World War and that incorporated into psychoanalysis, which was originally based on the discourse network of psychophysics, many cutting-edge ideas taken from the fields of cybernetics and computer science (in Seminar II, for instance, we find mention of Turing machines, Markovian machines, electronic computing machines, such as SEER⁸⁰ that was hardwired to play the game of Even and Odd, automata theory, formal languages, computer algorithms, halting, symbolic processing, recursivity, communications theory, codes, messages, closed circuits, cycles, loops, feedback structures, Boolean logic, logic gates, etc.)—ideas that are known to have surprised those who attended his 1954-5 seminar. It should be added that the novelty and level of difficulty of this material (perhaps, the equivalent today of theoretical quantum computing) required extensive study, which Lacan had undertaken with Claude Levy-Strauss, Émile Benveniste, and the mathematician Georges-Théodule Guilbaud.⁸¹ Unlike certain other ideas inspired by cybernetic concepts, such as those of textual machines and *mise en abyme*, that later became the fashion in the

new literary criticism, Lacan's handling of cybernetic concepts, as Jean-Pierre Dupuy⁸² has pointed out, was far from superficial.

Nonetheless, as Johnston has remarked, "Lacanian theory has pretty much ignored Lacan's interest in cybernetics, with no apparent loss of completeness or intelligibility. So, even if we agree that 'cybernetics clearly highlights . . . the radical difference between the symbolic and the imaginary orders,'⁸³ as Lacan asserts, we may wonder to what extent his introduction of machines is a handy illustration of his theory that doesn't add anything essential."⁸⁴ Drawing upon the work of Friedrich Kittler, Johnston stresses, quite to the contrary, the absolute "necessity of cybernetics to Lacan's theory,"⁸⁵ underscoring that when Lacan says "the symbolic world is the world of the machine,"⁸⁶ he is referring to computers (Markovian machines, finite state machines, and Turing machines). These machines form the basis of Lacan's "Seminar on 'The Purloined Letter,'" especially the postscript, as noted by Johnston, who unravels, like Fink before him, the emergence of law in the numeric encoding system and points out that both the 1-3 Network and α , β , γ , δ Network are transition diagrams of finite state machines that are "intended to show how the operation of a 'primordial symbol' can constitute a structure linking 'memory to law.'"⁸⁷

Yet what has not been recognized is that the three exercises taken together are themselves a machine, a computational model (one that Lacan carefully worked out by hand) of the *formation* of subjectivity (the latter term defined as "an organized system of symbols, aiming to cover the whole of an experience, to animate it, to give it its meaning,"⁸⁸ what Freud calls "*the core of our being*"⁸⁹). This model develops through the recursive application of two elementary functions that combine pre-established patterns (originating with a series of binary inscriptions) into groups of three⁹⁰ that are then labeled (rewritten) according to whether the patterns in a given group express symmetry or dissymmetry,⁹¹ evenness or oddness.⁹² What emerges after only two iterations clearly informs Lacan's understanding of the symbolic world as the world of the machine:⁹³ its autonomy and repetition (the insistence of the chain), its organization of structures and laws (possibilities and impossibilities), its transformations of probabilities (that subvert randomness), its consequence of lack (the *caput mortuum* of the signifier), and its mechanisms of retroaction. Lacan's intention in the suite is for the student to work out the computations for himself, so that his understanding of the symbolic world via this machine can be so informed. But for this to happen "he must pay the price with elbow grease [*mettre du sien*]."⁹⁴

Following Lacan's program by encoding alternations of absence and presence (the outcome of a flipped coin), we worked out how these alternations are transformed by sequentially grouping them by three, first to form the numeric code and then the Greek letter code, uncovering in the process the emergence of cycling behaviors in the case of codes that express evenness (symmetry) and bridging behaviors in the case of those expressing oddness (dissymmetry)—behaviors that in the letter code divide every letter in two (like the two sides of the original coin), the separate halves functioning as switches that both prohibit and permit certain

connections, linking together those letters that are so permitted into vast chains of codes, which, when halted or interrupted, retroactively delete antepenultimate codes, thereby situating each sequence into one of two interconnected quadrants. We discovered in this way that retroaction is always a possibility. Moreover, we encountered in the early stages of the letter code, two special moments, one at time four and one at time five, that produce deformations of the basic sequencing pattern—the consequence of a collision of moieties (a trauma, as it were) that rewrites the past, kicking into motion the gears of displacement. At this moment a structure and a mechanism for the subject’s entry into the symbolic are forged, autonomously, “independently of the peculiarities of its human support.”⁹⁵ What is generated thereafter are streams of self-similar patterns that are inversions of each other.

It is within the perspective of the Greek letter code that Lacan deciphers “The Purloined Letter,” which, inverted in position in the seminar, becomes for us a final exercise, one explicating the “intermixing of subjects.”⁹⁶ As Lacan tells us in the overture of the *Écrits*, “It will be up to the reader to give the letter in question . . . the very thing he will find as its concluding word: its destination.”⁹⁷ For what Poe’s tale illuminates for us is the *character* of the letter in the circuit of the symbolic, as it is “displaced in its pure state, which one cannot come into contact without being immediately caught in its play.”⁹⁸ Here the letter is “synonymous with the original, radical, subject.”⁹⁹ For each of us, it is our unconscious,¹⁰⁰ and it is:

Here we rediscover what I’ve already pointed out to you, namely that the unconscious is the discourse of the other. This discourse of the other is not the discourse of the abstract other, of the other in the dyad, of my correspondent, nor even of my slave, it is the discourse of the circuit in which I am integrated. I am one of its links. It is the discourse of my father for instance, in so far as . . . I am condemned to reproduce . . . the discourse he bequeathed to me, not simply because I am his son, but because one can’t stop the chain of discourse, and it is precisely my duty to transmit it in its aberrant form to someone else . . . in such a way that this discourse produces a small circuit in which an entire family, an entire coterie, an entire camp, an entire nation or half of the world will be caught.¹⁰¹

Appendix 1: Analysis of the (De)Materialization of Letters within the Letter Code at Times Four and Five

Understanding the (de)materialization of letters within the letter code at times four and five requires that we wade through a brief, albeit somewhat more arduous, analysis of the letter code, one that starts with an examination of the moieties implicated in the addition of the fourth letter. To assist us in this endeavor, Figure A1.1 provides tree diagrams grouped into their respective quadrants that map out the progressive transitions between moieties in all sixty-four combinations of four-letter sequences.

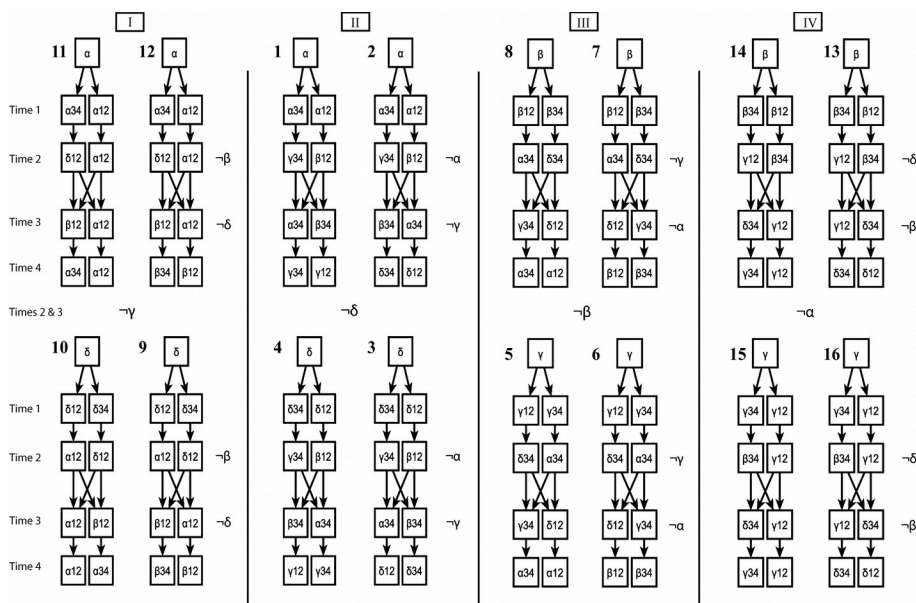

Figure A1.1. Tree Diagrams Representing All Legal Four-Letter Codes. Note: trees are numbered 1-16 to correspond with the arcs in Lacan's Tables Ω and O (see Figure 6) and are grouped into quadrants (labeled with Roman numerals) based on the missing letters at both times two and three.

Examining commonalities among the trees within a given quadrant, we notice that every tree shares two sets of moieties, one at time two and another at time three, with the two elements of each set belonging to only one category. For example, all trees in Quadrant III transition at time two to either $\alpha34$ or $\delta34$, both of which belong to category 0, and at time three to either $\gamma34$ or $\delta12$, both of which belong to category 1. Moreover, none of the other quadrants have trees that transition to these same moieties at these particular times. In other words, at times two and three, a letter is never fully expressed by both its moieties within a single quadrant nor is the moiety combination at each of these time steps ever duplicated in another quadrant.

A further observation concerns the starting and ending letters of trees within a quadrant. As is the case with times two and three, letters at time one are not distributed evenly throughout the quadrants but rather are confined to two, with α and δ restricted to Quadrants I and II, and β and γ to Quadrants III and IV. The case is similar for terminating letters: the trees in Quadrants I and III all end in α and β , whereas those in Quadrants II and IV all end in γ and δ . Thus, we discover that the first and last letters of a sequence function much like a set of coordinates that positions a sequence within a specific quadrant.¹⁰² These quadrants are

defined as (*start letters; terminating letters*): Quadrant I: (α, δ ; α, β), Quadrant II: (α, δ ; γ, δ), Quadrant III: (β, γ ; α, β), and Quadrant IV: (β, γ ; γ, δ).

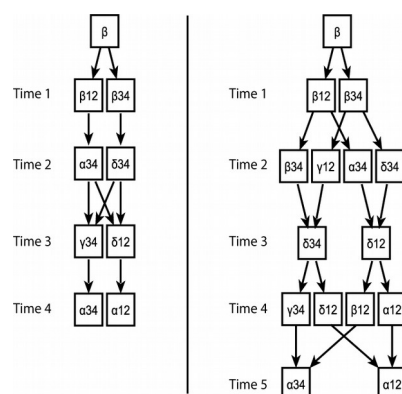

Figure A1.2. Trees at Times One through Four and One through Five for β to α .

With these observations in mind, it is time to explore what happens when more letters are added. As Lacan notes when speaking about the Δ Distribution for time three and as the trees in Figure A1.1 confirm, at time four it is possible for any starting letter to terminate at any other letter, unlike time three, which is restricted, as we have already discussed, to two letters that directly depend on the starting letter. The trees in Figure A1.1 also confirm the obvious that every letter at the terminating point of a tree is represented by both its moieties. While all letters remain a possibility in position four when a fifth letter is added (with the difference being that every letter is now represented in every tree at position four), the moieties of one category drop out. The category that remains in position four is determined by its quadrant location and is the same category that was in the penultimate position of the four-letter trees before the fifth letter was added. Consider, for example, the five-letter strings beginning with β and ending in α . The penultimate moieties for these five-letter sequences, as illustrated in Figure A1.2, are restricted to category 1, just as they are in the penultimate position of the four-letter sequences. That this must be so can be demonstrated quite simply by examining the outputs of the moieties in Figure 5: only category 1 moieties output α letters. Similar restrictions apply at time two, where the moieties in our example are limited to category 0, a limitation that in this case can be explained by the fact that only category 0 moieties have β inputs.

The patterns we have just uncovered in these two examples persist as more letters are added and can be generalized, as reflected in Table 2, as follows. Given some sequence of any length greater than three, the penultimate letters (where time $t=n-1$, with n being the length of the string) and all second letters (where $t=2$) are represented by moieties belonging to one category, a category that is determined by its quadrant position (that is, by its first and last letters). Two

letters appear at time three ($t=3$) and in the antepenult position ($t=n-2$), as illustrated in Figure A1.3, which shows sample trees for sequences of length six and seven. This follows naturally from the categories of moieties in the second and penultimate positions, the two letters in position three due to the fact that a single category only outputs two letters, and the two letters in the antepenult position caused, as described in the main text, by quadrant displacements.

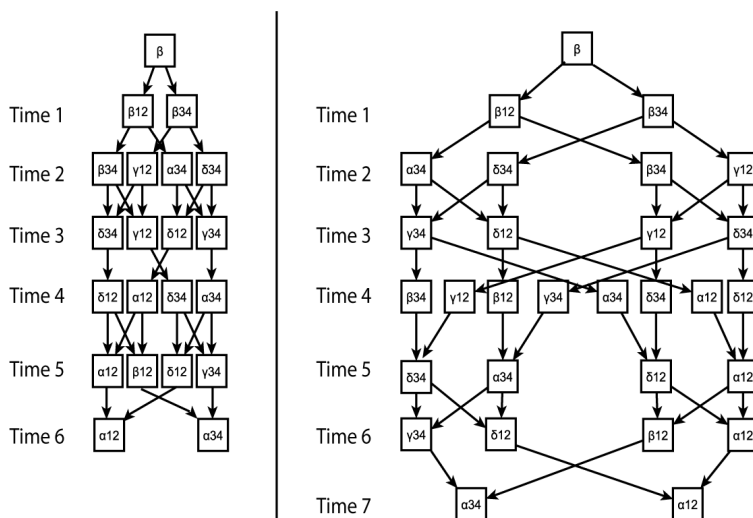

Figure A1.3. Trees at Times One through Six and One through Seven for β to α .

The question now arises whether it is the case that this general pattern holds for four-letter and five-letter sequences since some moieties that should be there are missing in the second, third, and penultimate positions (compare Table 2 with Figure A1.2). The missing moieties in these key positions can be explained by observing that the inputs and outputs of the moieties in the second and penultimate positions coincide in shorter sequences. For example, the four-letter tree in Figure A1.2 has moieties belonging to category 0 in the second position, as expected for the pattern of letter succession in Quadrant III, but only α_{34} and δ_{34} are present in position two, missing are the category 0 moieties β_{34} and γ_{12} . This can be explained by the fact that time two is also the input position ($t=n-2$) for the moieties of category 1 in the penultimate position. This leaves only α_{34} and δ_{34} (the only category 0 moieties that are also category 1 inputs) for position two (removing β_{34} and γ_{12} since they cannot function as inputs to category 1 moieties), and only γ_{34} and δ_{12} in the penultimate position as they are the only category 0 outputs for the remaining moieties in position two. With the five-letter example in Figure A1.2, the situation is slightly different. Following the general rule, all category 0 moieties are represented at time two and all category 1 at time four (the penultimate position), but time three is both the output of the first set of

moieties in position two and the input to the second set of moieties in the penultimate position, a collision that eliminates at time three all but the δ moieties (note that category 0 moieties output the set $s1 = \{\gamma12, \gamma34, \delta12, \delta34\}$ and category 1 inputs belong to the set $s2 = \{\alpha12, \alpha34, \delta12, \delta34\}$; the intersection of $s1$ and $s2$ is δ , that is, $s1 \cap s2 = \{\delta12, \delta34\}$).

As a final note, let me counter a possible objection to the partitioning of sequences into quadrants. It might be argued, for instance, that merging Quadrants I with II and Quadrants III with IV (see Table 2) would produce a much simpler albeit less interesting pattern of letter succession, where, for any sequence larger than three, any letter/moiety (*All*) would follow thereafter. One might even hypothesize that this is the general pattern Lacan discerned for larger sequences (until halted, *All* is the pattern) and the reason he stopped his analysis of the letter code at time four. Yet the fact remains that not only does Lacan partition four-letter sequences in Tables Ω and O into quadrants based on the letters that disappear at times two and three, but he also foregrounds this “hole that opens up,” that makes the signifier “depend on absence, obliging it to *repeat its contour* [emphasis added].”¹⁰³ This repetition reflects the very form of memory (*repetition automatism*) that Freud was the first to discover. Objections that these fissures extend indefinitely can be countered by examining the patterns produced by trees of letter codes of varying lengths, such as those provided in this appendix, where it can be observed that specific pairs of letter delimiters do indeed produce the patterns of missing letters as described in Table 2, confirming that the contours of absence that Lacan observed for four-letter sequences persist over time (although in a slightly different form due to the deformations at times four and five of a more general pattern as noted above). The reason quadrants materialize at time four with the four-letter codes is because each letter is divided into two, and the moieties segregate letters at time three into two input and two output pairs, which in turn produce at time four a 2×2 combination of delimiting pairs.¹⁰⁴ It wasn’t until the 1966 edition of the *Écrits* that Lacan introduced the $\alpha, \beta, \gamma, \delta$ Network, the graph that recognizes the binary nature of the letters. One can only speculate what Lacan would have worked out had he elevated this graph’s status as lowly footnote to a position warranting a more thorough analysis of the binary letters.

Appendix 2: Some Remarks on the L Chain Language and Its Formalization

My reading of the rules informing the L Chain is provided below along with a regular expression defining each rule. A regular expression is a set of symbols that formally define a legal expression within a given language. Because parentheses are a metacharacter in regular expressions (and must be *escaped* with a backslash to indicate a literal parenthesis which in the case of the L Chain language would add clutter to the expression), I use the roman letters b and d to designate β and δ in the list of rules rather than parentheses but retain Lacan’s final transcoding of α and γ to 1 and 0 for those two letters. After describing each rule, I provide a full description of the L Chain language as one regular expression, transcribing b and

d back into parentheses as Lacan preferred. This regular expression along with variations to the L Chain can then be plugged into any online regular expression tester to validate the string. This should prove useful to scholars wanting to explore legal variations of the L Chain or other expressions within this language, as I demonstrate below when analyzing what Lacan says about the reverse of the L Chain and what it teaches us about the effects of the letter in the “The Purloined Letter.”

Unfortunately, there are ambiguities in Lacan’s description of the L Chain language in “Parenthesis of Parentheses.” He begins clearly enough by transcribing β into a right parenthesis and δ into a left parenthesis, calling the double cycle $\beta\beta\delta\delta$, transcoded as (()), “quotes.”¹⁰⁵ What is misleading is his expansion of the “quotes” to include (() () . . . ()), which on its own is not a legal statement in the letter encoding scheme: the sequence $\beta\delta\beta$, or () (, is illegal. I believe that what Lacan is specifying here is that between the first and last parentheses making up the quotes there can be any number of sets of parentheses, however that might be formulated *legally*.¹⁰⁶ It should be noted that my interpretation of the five rules appears to be in agreement with Fink’s commentary on the rules informing the L Chain;¹⁰⁷ that this interpretation is correct is lent weight when these rules are compared to features evident in Lacan’s α , β , γ , δ Network (see Appendix 5).

The Five Rules of the L Chain Language

Given the basic string *bbdd*:

- 1) Zero or more *bd* can occur between the first and last *b . . . d* in the basic string as long as at least one *0* is inserted¹⁰⁸ between any *db* in the series *bdb* (for example, *bbd0bdd*).

Regular expression for rule 1: $^b((bd)|((bd)^*(bd0bd)+(bd|0bd)^*))d\$$

- 2) Zero or more *10* strings (pairs) can be inserted between *bb* in the basic string (for example, *b10bdd*), and zero or more *01* strings can be inserted between *dd* in the basic string, as long as the number of signs added is even (for example, *bbd01d*);

Regular expression for rule 2: $^b(10)^*(bd)+(01)^*d\$$

- 3) Zero or more *0101* strings can be placed between any *bd . . . bd* combination placed inside the basic string but add a *0* at the end if one or more *0101* strings are inserted there (for example, *bbd01010bdd*);

Regular expression for rule 3: $^b(10)^*((bd)|((bd)^*(bd((0101)^*0101)?bd)+(bd|((0101)^*0101)?bd)^*)(01)^*d\$$

- 4) Zero or more *0* signs can be inserted between any *bd* located inside the basic string (for example, *bb000db000dd*);

Regular expression for rule 4: $^b(b0^*d)+d\$$

- 5) Zero (based on the L Chain example) or more 1 signs (as well as zero or more bd frames stuffed with one or more 1010 sequences, but add a final 1 before the d) can be placed *outside* the basic bddd string;¹⁰⁹ In other words, this rule applies to what goes before and after the basic string (for example, 111bddd111b10101d111). Any bd here must be stuffed with at least one 1 to be a legal letter code, so I am reading the last line of this rule, namely, “the number of signs being zero or odd,”¹¹⁰ as referring to the total number of signs involving the bd frame (and that number would be zero if no bd and odd if any), and not as referring to the number of signs inside and excluding the bd frame.

Regular expression for rule 5: $^(1^*(b(1010)+1d)^*(bddd)(1^*(b(1010)+1d)^*)^*$

Transcoding β and δ back into parentheses, Lacan provides the following application of these rules in the L Chain: “(10...(00...0)0101...0(00...0)...01)11111...(1010...1)111....etc.”¹¹¹ Thus, one legal string in the L Chain language is (10(000)01010(000)01)11111(10101)111. This string, as well as others in this language, can be verified online at <https://regex101.com/> using the following regular expression, which combines all five rules defining this language:

$^(1^*(\backslash((1010)+1\backslash))^*(\backslash(10)^*(\backslash(0^*\backslash))|(\backslash(0^*\backslash))^*(\backslash(0^*\backslash))((0101)^*01010)|0\backslash(0^*\backslash))+(\backslash(0^*\backslash)|((0101)^*01010)|0\backslash(0^*\backslash))^*(01)^*\backslash(1^*(\backslash((1010)+1\backslash))^*)^*$

In speaking about the laws of remembering (*mémoration*) as they are reflected in the L Chain, Lacan writes, “the same dissymmetrical structure persists [in the L Chain] if, for example, we reverse all the quotes.”¹¹² The dissymmetrical structure Lacan speaks of is a reference to two segments in the L Chain: one located on the left-hand side representing the subject, which is dominated as we have seen by the γ_{12} iterative engine (the strings of zeros in the L Chain) but which also includes the displacement patterns generated within various configurations of β - δ as γ_{12} crosses over to the imaginary axis; and the other segment situated on the right-hand side representing the Other, which is dominated by the α_{12} iterative engine (the strings of ones) but which likewise includes displacement patterns generated within β - δ shells. These two sides are highlighted here within the L Chain: (10...(00...0)0101...0(00...0)...01)11111...(1010...1)111.

In explaining the dissymmetric structure that remains after reversing the quotes in the L Chain, Fink considers two strings: the L Chain proper with all parentheses reversed:)10)000(01010)000(01(11111)10101(111, which he dismisses for not being a legal letter expression; and)01)111(10101)111(10(00000)01010(000,¹¹³ which, in addition to reversing the quotes, flips all zeros and ones to their opposite values. The resulting string is a permissible letter string and one which he investigates. It is not, however, a legal expression in the L Chain language, as can be confirmed

by plugging this string (along with the regular expression defining the L Chain language worked out above) into a regular expression tester. The L Chain language is but a subset of the letter code: thus, although it is true that all L Chain strings are legal letter strings (when translated), the converse is not true. A perfectly legal string in the L Chain language can be generated, however, if we simply take advantage of the fact that each of the two segments highlighted above is essentially palindromic, that is, if we reverse the elements in the original L Chain (with ellipses removed) to obtain 111)10101(11111)10)000(01010)000(01(and then flip the parentheses to produce 111(10101)11111(10(000)01010(000)01). This string is interesting because it swaps what was originally on the left-hand side of the L Chain (that is, what is allowable inside the “quotes” covering the subject) with what was on the right-hand side (that is, what is allowable outside the “quotes” in the field of the Other)—effectively turning the L Chain inside out.

Lacan uses the reversibility of the L Chain to cast light on how the letter in “The Purloined Letter” “was able to have its effects on the inside—on the tale’s actors, including the narrator just as much as on the outside—on us, its readers, and also on its author.”¹¹⁴

Appendix 3: Pure Code Prefixes and Suffixes

As mentioned in the text, there are sixteen pure codes that persist in their starting quadrants no matter the length of the sequence. These pure codes are essentially composed of two roots, the α_{12} and γ_{12} self-loops or iterative engines, each of which dominates or drives their own separate quadrants, as noted in Table A3.1.¹¹⁵ Attached to these two roots are seven possible prefixes ranging in size from one to three letters and three possible suffixes of one or two letters. The prefixes and suffixes serve the dual functions of situating the sixteen pure codes within their respective quadrants and of generating the displacement patterns discussed in the text (that is, of forging links that connect two quadrants that are dominated by opposite roots, specifically Quadrant I with II, as illustrated by the displacement patterns in Figure 7, and Quadrant IV with III, as illustrated in Figure 9 by the displacement patterns produced by β_{12} and β_{34}).¹¹⁶ It should also be noted that the infinite sequences α^+ (α_{12}) and γ^+ (γ_{12}) are located only in Quadrants I and IV, respectively. Obviously, these two sequences can never be interconnected. What this means is that Quadrants I and IV, as well as the two quadrants these two are linked with (II with I and III with IV), can never be interconnected either.¹¹⁷

Quadrants I & III			Quadrants II & IV		
Prefix	Root	Suffix	Prefix	Root	Suffix
(δ 12)	(α 12)	(β 12)	(β 34)	(γ 12)	(δ 34)
(α 34)(δ 12)		(β 12)(α 34)	(γ 34)(β 34)		(δ 34)(γ 34)
(δ 34)(δ 12)		(β 12)(β 34)	(β 12)(β 34)		(δ 34)(δ 12)
(β 34)(δ 34)(δ 12)			(δ 12)(β 12)(β 34)		
(β 12)(α 34)(δ 12)			(δ 34)(γ 34)(β 34)		
(γ 12)(δ 34)(δ 12)			(α 12)(β 12)(β 34)		
(γ 34)(α 34)(δ 12)			(α 34)(γ 34)(β 34)		

Table A3.1. Prefixes and Suffixes Attached to the Self-Loops α 12 and γ 12. Note: roots are missing in some pure strings at time five (see footnote 115).

Rather striking in Table A3.1 is the dominance of β and δ in the composition of the prefixes and suffixes, with β forming all the α 12 suffixes and δ all the γ 12 suffixes (recall from Figure 5 that α 12 and γ 12 output either themselves or β 34 or δ 34, respectively). The dominance of β and δ in the composition of the suffixes reflects the fact that these letters are primarily responsible for connecting Quadrants I with II and Quadrants IV with III and thus for generating the displacement patterns, which, as noted in the main text, are the result of surmounting “one or several parenthetical signs.”¹¹⁸

In functioning as prefixes and suffixes, we discover that β and δ act not only as connectors but also as delimiters—much like a pair of parentheses. Lacan’s transcoding of β and δ into a set of parentheses becomes all the more fitting considering how these codes function as containers for different α and γ combinations in the L Chain language. In the α , β , γ , δ Network, as noted in Appendix 5, β and δ moieties even assume the shape of a box.

Appendix 4: Code Inversions

The basic displacement patterns revealed in Figure 9 can be grouped, as pointed out in the main text, into pairs that are inverses of each other. Moreover, since the displacement patterns are fractals, we observe these basic patterns repeating themselves, with smaller versions embedded within larger ones.

If we inspect the letters making up the inverted patterns (see the four samples in Figure A4.1), we discover that certain codes are the flipside of certain others: α 12 and γ 12 are inverses of each other as are α 34/ γ 34, β 12/ δ 34, and β 34/ δ 12. These inversions are observable as well in the binary encodings of these moieties in Lacan’s α , β , γ , δ Network (see Figure A5.1 in Appendix 5), where the binary digit 1 represents a symmetric numeric code and binary 0 a dissymmetric numeric code (the inverses are evident in Figure 3 as well).

Samples 1-2		Samples 3-4											
α12	γ12	α12	α12	α12	α12	α12	α12	α12	α12	α12	α12	α12	α12
α12	γ12	β12	β12	β12	β12	β12	β12	β12	β12	β12	β12	β12	β12
α12	γ12	β34	β34	β34	β34	β34	β34	β34	β34	β34	β34	β34	β34
α12	γ12	γ12	γ12	γ12	γ12	γ12	γ12	γ12	γ12	δ34	δ34	δ34	δ34
β12	δ34	γ12	γ12	γ12	δ12	δ34	δ34	δ34	δ34	γ34	γ34	γ34	γ34
α34	γ34	γ12	γ12	δ34	δ34	γ34	γ34	δ12	δ12	α34	α34	β34	β34
γ34	α34	γ12	δ34	γ34	δ12	α34	β34	α12	β12	γ34	δ12	γ12	δ34
α34	γ34	γ12	γ12	γ12	γ12	γ12	γ12	γ12	γ12	γ12	γ12	γ12	γ12
γ34	α34	δ34	δ34	δ34	δ34	δ34	δ34	δ34	δ34	δ34	δ34	δ34	δ34
α34	γ34	δ12	δ12	δ12	δ12	δ12	δ12	δ12	δ12	δ12	δ12	δ12	δ12
γ34	α34	α12	α12	α12	α12	α12	α12	α12	α12	β12	β12	β12	β12
α34	γ34	α12	α12	α12	α12	β12	β12	β12	β12	α34	α34	α34	α34
γ34	α34	α12	α12	β12	β12	α34	α34	β34	β34	γ34	γ34	δ12	δ12
α34	γ34	α12	β12	α34	β34	γ34	δ12	γ12	δ34	α34	β34	α12	β12

Figure A4.1. Samples of Repeated Patterns (Extracted from within Larger Patterns) and Their Inversions. The inverted pairs seen here are binary complements of each other. The moiety (binary) complements are α12/γ12 (111/000), α34/γ34 (101/010), β12/δ34 (110/001), and β34/δ12 (100/011). Note: the four patterns labeled and shuffled in Figure 9 do not necessarily begin with a binary complement even though the patterns are identical: a single β or δ prefix starts off patterns for strings beginning with β or δ (these two letters form complements with each other but not with α and γ, which also initiate some of the same patterns). After this first letter exception, all inverted pairs of patterns and subpatterns are composed of the same binary complements, as illustrated here.

A great deal could be written about these inverted pairs, whether in terms of their relation to each other within the various graphs presented in this text and in the suite or whether in terms of their histories—stretching back to the point of their origin: the coin whose two sides are the antecedents of these binary complements.

Appendix 5: Comparison of the L Schema, the L Chain Language, and Lacan’s α, β, γ, δ Network

Arguably the most elegant expression of the letter code is Lacan’s α, β, γ, δ Network,¹¹⁹ which, like the transition diagram in Figure 4, traces out all possible letter codes. Although both graphs completely express the letter code, they are essentially different, the transition diagram offering a diachronic perspective (as well as a synchronic description) of the letter code.¹²⁰ Lacan’s α, β, γ, δ Network, however, might also be thought of as "diachronic"—that is, insofar as it reveals to us something of the origin of the rules defining the L Chain language and its link to the L schema (which is reprinted below for ease in comparison).

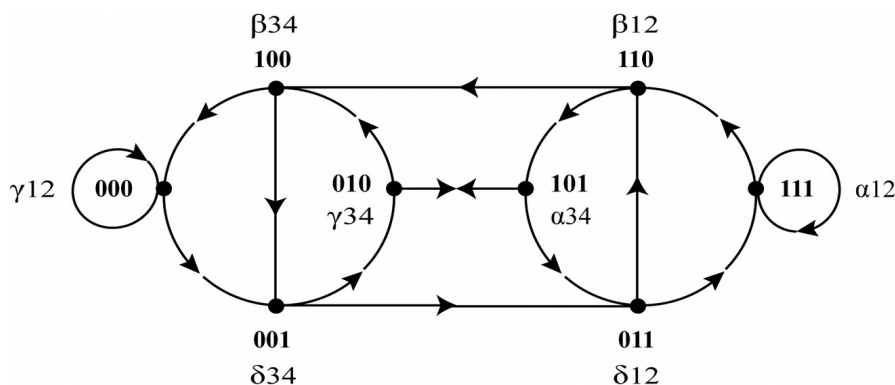

Figure A5.1. Lacan's α , β , γ , δ Network with Moieties Labeled.

What is perhaps most striking in the α , β , γ , δ Network is the contrast between the four circles and the central square defined by $\beta\beta\delta\delta$. Also of note is the bridge defined by $\gamma34$ and $\alpha34$ that connects the two (vertical) symmetric halves of the graph. I believe it highly likely that Lacan's L Chain language was directly inspired by these features in the α , β , γ , δ Network. There is, for example, the aforementioned prominence of the $\beta\beta\delta\delta$ structure,¹²¹ with $\gamma34$ and $\alpha34$ clearly contained inside this structure in ways prescribed by the L Chain language. One could say, in fact, that the entire L Chain language is defined in terms of the $\beta\beta\delta\delta$ structure as it is configured in the α , β , γ , δ Network. In the L Chain language, for instance, cycles of $\gamma34$ and $\alpha34$ iterate between any number of $\beta\delta$ - $\beta\delta$ combinations (rule 3 in Appendix 2), as clearly evident in the network by the left-hand vertical edge ($\beta34$, $\delta34$) of the square and the path defined by the right-hand side of the circle it bisects (that allows for any number of crossings back and forth on the bridge). Situated on the left-hand side of that same circle is $\gamma12$, where it potentially self-loops any number of times between $\beta34$ and $\delta34$ (rule 4). In contrast to the $\gamma12$ loop, the $\alpha12$ loop in the L Chain language is defined as lying outside the $\beta\beta\delta\delta$ structure, where it can self-loop indefinitely (rule 5). Given the direction of the arcs (and assuming precedence of the $\beta\beta\delta\delta$ structure), one can see in the network why Lacan defines $\alpha12$ as the exit point of the $\beta\beta\delta\delta$ structure¹²² (and since $\alpha12$ is associated with the Other, this placement fits perfectly). Moreover, the L Chain language allows for indefinite iterations of $\alpha12$ and its walk around the right-hand circle bisected by the $\beta12$ and $\delta12$ edge, whose letters in the L Chain language are stuffed as well with any number of potential $\alpha34$ and $\gamma34$ cycles (rule 5).

Rules 1 and 2 are also clearly evident in the α , β , γ , δ Network. Rule 1 walks (in part) through $\beta34$, $\delta34$, $\gamma34$, and $\beta34$, whereas rule 2 takes two main paths inside the $\beta\beta\delta\delta$ structure: one path through $\beta12$ and any number of $\alpha34$ and $\gamma34$ cycles followed by $\beta34$ and a second path, its reflection, through $\delta34$ and any number of $\gamma34$ and $\alpha34$ cycles followed by $\delta12$.

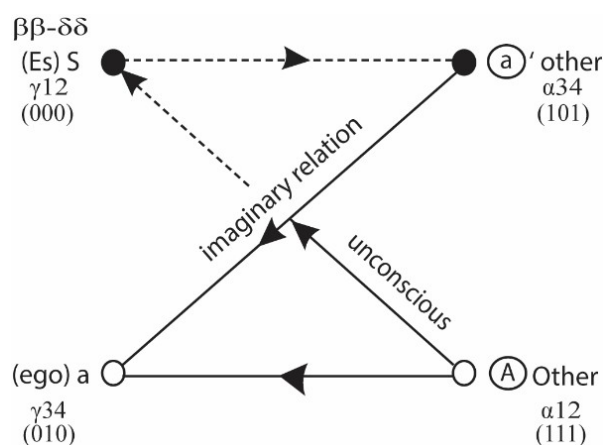

Figure A5.2. L Schema with Associated Moieties and Binary Codes.

How does the α , β , γ , δ Network correspond to the L schema? Although the $\beta\beta\delta\delta$ structure connects the two larger circles and frames the connecting bridge, it also separates the bridge from the two self-loops located at the two ends of the structure. The bridge, as discussed in the text, is associated with the imaginary relation, whereas the outer loops represent the symbolic axis. However, as noted above, γ_{12} (which corresponds with Es) lies within the $\beta\beta\delta\delta$ structure. It is interesting to point out at this juncture that the letter γ is twisted, not only in appearance but also in its function. Unlike the other letters, γ_{12} (the interweaving self-loop), is the only loop represented in category 0 moieties, all the others being connections between three points; this in turn leaves γ_{34} as the only three-point connector in category 1, which otherwise is composed of cycling moieties. The inversion of α (see Appendix 4) and true to its twisted shape, γ is not only the stitch that ties together the two categories of moieties but also for Lacan a *point de caption* (“moments of silence, a value of scansion”¹²³). In contrast, α is the other/Other, with α_{12} Other by virtue of lying entirely outside the structure. Contemplating the α , β , γ , δ Network, α_{12} , especially α_1 , which Lacan calls “the unary trait,”¹²⁴ could also be considered the alpha and omega of both the L schema and Lacan’s letter code.¹²⁵

¹Jacques Lacan, *Écrits: The First Complete Edition in English*, trans. Bruce Fink (New York: Norton, 1996) 42. Note: the original pagination of the *Écrits* 1966 edition is used throughout.

²Lacan, *Écrits*, 42. The antecedents of the pronouns in the original, preserved in the translation, are nuanced and lend themselves to several interpretations of this passage.

³Bruce Fink, “The Nature of Unconscious Thought or Why No One Ever Reads Lacan’s Postface to the ‘Seminar on ‘The Purloined Letter,’” *Reading Seminars I and II: Lacan’s Return to Freud*, eds. Feldstein, Richard, Bruce Fink and Maire Jaanus (Albany, NY: State University of New York Press, 1996) 173-91.

⁴Lacan, *Écrits*, 41. This passage lends itself to several interpretations.

⁵Lydia H. Liu, “The Cybernetic Unconscious: Lacan, Poe, and French Theory,” *Critical Inquiry* 36.2 (2010): 288-320; 289.

⁶Lacan, *Écrits*, 42.

⁷Lacan, *On Feminine Sexuality, the Limits of Love, and Knowledge: Book XX Encore (1972-1973)*, trans. Bruce Fink (New York and London: Norton, 1975) 30.

⁸Lacan, *Écrits*, 46.

⁹Lacan, *Écrits*, 43.

¹⁰Lacan, *Écrits*, 44.

¹¹Lacan, *Écrits*, 43.

¹²Lacan, *Écrits*, 46.

¹³Lacan, *Écrits*, 45.

¹⁴Lacan, *Écrits*, 47.

¹⁵I am referring here to Lacan’s discussion of the pluses and minuses in *The Seminar of Jacques Lacan Book II: The Ego in Freud’s Theory and in the Technique of Psychoanalysis (1954-1955)*, trans. Sylvania Tomaselli (Cambridge: Cambridge University Press, 1972) 192-193.

¹⁶Persi Diaconis, Susan Holmes, and Richard Montgomery, “Dynamical Bias in the Coin Toss,” *SIAM review* 49.2 (2007): 211-35; 211.

¹⁷Sigmund Freud, “Determinism, Belief in Chance and Superstition—Some Points of View,” *The Standard Edition of the Complete Psychological Works of Sigmund Freud*, vol. VI, trans. James Strachey, ed. James Strachey et al. (London: Hogarth, 1900/1953) 239-80. Hereafter *Standard Edition*.

¹⁸Lacan, *Sem. II*, 192 (see also 182).

¹⁹Lacan, *Sem. II*, 192.

²⁰Lacan, *Sem. II*, 192-193.

²¹The following figure highlights the retrogressive step when encoding a plus/minus sequence into a series of numeric codes:

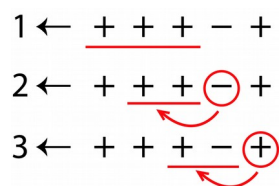

²²Lacan, *Écrits*, 47.

²³Lacan, *Écrits*, 48.

²⁴Thus, 11^+ is the set of strings {11, 111, 1111, . . . } and is used here to mean that 1 goes to 1, or makes a loop in the 1-3 Network at least once (11), if not more than once (11^+). I use a superscript to distinguish the Kleene operator from the plus sign.

²⁵The 22^+ cycle, circulating as it does between two points, is different from the 11^+ and 33^+ cycles, which revolve around one point; these single point cycles, as we have seen, will be referred to as either *cycles*, *loops*, or *self-loops*, but multipoint cycles will always be referred to as *cycles*.

²⁶Here I am noting the *delimiters of numeric triples* in terms of evenness and oddness (of course, by definition, 1 and 3 each represent *even +/-* triples).

²⁷This is a generalization of the rule that Lacan partially specifies. Note that the dash between numbers means that any number of 2s can be inserted between the 1 and 3 numeric delimiters. Walking through the 1-3 Network with the following (legal) sequences will confirm the general rule: [1221], [3223], [12223], and [32221]. Two impossible sequences would be [12221] and [323]. Note as well that although one need not count all 2s inside the delimiters to know whether the number of 2s inside is even or odd, both delimiters are necessary to make this determination (otherwise there is no way of knowing whether a series of 22^+ began with $\hat{2}$ or $\check{2}$). Delimiters play a key role not only in defining the numeric and Greek letter codes but also in the properties that emerge from these codes. Moreover, the idea of delimiters is repeated and transformed as one advances through the exercises, as are the ideas of evenness/oddness and the coin's two-sidedness.

²⁸Lacan, *Écrits*, 48.

²⁹The dot symbol here indicates any legal (given the context) numeric code (1, 2, or 3).

³⁰Thus, there are 4^3 combinations (four numbers, given the two 2s, grouped by three).

³¹In other words, it reflects the two types of succession in the numeric code: *viz*, the addition of a sign that loops (repeats) or one that simply arcs or branches (that is, one that is different, not reflexive).

³²Lacan, *Écrits*, fn. [28] 61. In the α , β , γ , δ Network, the binary number 1 encodes the symmetric numeric codes 1 and 3, and binary number 0 encodes the dissymmetric numeric code 2. Thus, the binary digits in parentheses beneath the Greek letters at the top of Figure 3 define each of the letters.

³³Lacan, *Écrits*, 51.

³⁴Although it is true that there are connections from α to β to α ; α to δ to α ; and γ to δ to γ , these sequences are not true cycles since they do not return to the same point, or moiety (defined later in the text) as observable in Figures 3 and 4. Likewise, neither $\beta\beta$ nor $\delta\delta$ connect back to their points of origin, that is, to their originating moieties (as most clearly seen in Figure A5.1 in Appendix 5) though they do make a single letter loop. For this reason, β and δ , as well as the sequences listed above, are unable to loop indefinitely.

³⁵Lacan, *Écrits*, 51. It is immaterial whether a record of pluses and minuses is produced completely at random or not. The same general structures of possibility and impossibility in the numeric and Greek letter codes would still emerge, along with variations in the

probabilities of certain letters that Lacan speaks of here (in fact, as noted in fn. 74, the probabilities for α and γ change over time if quadrants are taken into consideration).

³⁶Lacan, *Écrits*, 51.

³⁷Defining code X_i as in Figure 3, with $X = \{\alpha, \beta, \gamma, \delta\}$, $i = \{1, 2, 3, 4\}$, and X_i representing one of the four numeric triples defining a letter, it can be observed that in general, X_1 and X_2 flow together in the transition diagram, as do X_3 and X_4 ; however, as already mentioned, the X_1 and X_2 pairs diverge slightly in the α and γ self-loops, remaining separate in the α self-loop and interchanging in the γ self-loop. For this reason, all four possible combinations for each letter are separated in the graph and not collapsed (as later in the text) into their abbreviated forms X_{12} and X_{34} . The intention is for the transition diagram to reveal the underlying numeric compositions of the letters as well as all legal transitions between letters.

³⁸Lacan, *Écrits*, 54-55.

³⁹Lacan, *Écrits*, 55.

⁴⁰Lacan, *Écrits*, 55. The association of γ with the drives is all the more appropriate if we consider the pounding pulsation produced by the underlying plus/minus patterns informing the 2 cycle that drives the γ^* iterative engine. Ignoring the initial plus/minus in two of the triples defining 2^* , γ^* is essentially the redoubled alternation of the pluses and minuses informing code 3: $[++--++--++--++--...]$ and its reverse.

⁴¹Lacan, *Écrits*, 53.

⁴²Lacan, *Écrits*, 56.

⁴³Lacan, *Écrits*, 56.

⁴⁴Lacan, *Écrits*, fn. [28] 61. Reproduced in Figure A5.1 in Appendix 5. Note: when Lacan says a letter cannot be partitioned, he is speaking about the *materiality* of the letter (see *Écrits*, 24). At issue in this paper and Lacan's network are the mechanisms of letter connections. In the Greek letter encoding scheme, letters interconnect with other letters, including themselves, using two switching mechanisms. What follows in this paper is an analysis of the inner workings of these switches and their collective productions. Viewed from this perspective, each of the Greek letters, as Lacan rightly observes, is best represented as two.

⁴⁵Lacan, *Écrits*, fn. [28] 61.

⁴⁶Lacan, *Écrits*, 49.

⁴⁷Lacan, *Écrits*, 49.

⁴⁸Lacan, *Écrits*, 49. Lacan's reference to anthropology at time three is one of the reasons I call the letter divisions *moieties*.

⁴⁹We also saw this filtering mechanism, or gating, at work when grouping both the plus/minus codes and the numeric codes into threes, a process that renders some numeric and letter combinations legal and some illegal.

⁵⁰Lacan, *Écrits*, 50.

⁵¹See Appendix 1.

⁵²These shared missing letters defining the quadrants can be verified by inspecting the

four-letter trees in Figure A1.1 in Appendix 1.

⁵³Lacan, *Écrits*, 50.

⁵⁴Lacan, *Écrits*, 50.

⁵⁵Indeed, at the end of the “Introduction,” Lacan refers to “the times distinguished above” as the “first *finished* [emphasis added] form of the symbolic chain.” Lacan, *Écrits*, 54. See also the end of Appendix 1 for another theory.

⁵⁶To be fair Lacan died before personal computers were commonplace; his analysis of the code, I will assume, was entirely worked out by hand.

⁵⁷It should be noted that the two binary patterns for each quadrant in Table 2 representing the moiety category numbers in position two and in the penultimate position are the same as those defining the Greek letters in Figure 3 (that is, they are the same as the top binary delimiters printed beneath the letters in parentheses, *viz.*, 1.1, 1.0, 0.0, and 0.1). Recall that moieties are defined in terms of patterns of symmetry and dissymmetry. This is a fascinating topic in its own right.

⁵⁸Consulting Figure 6 we find that these three letters are missing either at times two or three or at both times.

⁵⁹Numbering the columns in Figure 7 one through sixteen, α_{12} and δ_{12} have displacements spanning column five to column twelve and that cut across both quadrants as illustrated in Figure 7; α_{34} and δ_{34} have displacements from column one to four in the second quadrant and from thirteen to sixteen in the first quadrant; β_{12} and γ_{34} have displacements from column one to four in the third quadrant and from thirteen to sixteen in the fourth quadrant; and β_{34} and γ_{12} have displacements from column five to column twelve that span quadrants IV and III. Quadrants are defined here according to time four. Thereafter in time, they increasingly become interwoven.

⁶⁰Each quadrant has two starting letters and each letter is composed of two moieties spanning two quadrants. Since each moiety produces four pure codes (see Figure 7) per quadrant and four moieties define every quadrant, the total number of pure codes in a given quadrant is sixteen.

⁶¹Thus, pure codes make up a diminishing fraction of sequences as their length grows. Starting with one of the eight moieties, the total number of combinations of length $n \geq 4$ is 2^{n-1} , and the total number of transitions between quadrants is $2^{n-2}(n-4)$, though the maximum number of displacements within a single string is $n-4$.

⁶²See Appendix 3 for a table of pure code prefixes and suffixes attached to these roots. Note that they are dominated by β and δ , these symbols functioning as transitions between the symbolic and imaginary axes, as discussed in the next paragraph.

⁶³Lacan, *Écrits*, 53. In “Parenthesis of Parentheses,” Lacan transcribes γ as 0 and α as 1 and associates these two letters (specifically, γ_{34} and α_{34}) with aa' in the L schema, writing “It is then the alternation of the 01s that represents the imaginary grill (aa') of the L schema.” (55). See also fn. 64.

⁶⁴“It remains for me to define the privilege of the alternation characteristics of the between-two of the quotes (01 [$\gamma\alpha$] pairs)—that is, of the status of a and a' in themselves,” Lacan, *Écrits*, 55.

⁶⁵Lacan, *Écrits*, 56.

⁶⁶Lacan, *Écrits*, 56.

⁶⁷Lacan, *Écrits*, 56. See as well my discussion of β and δ in Appendices 2, 3, and 5, where I show how β and δ function as both connectors and containers (prefixes and suffixes).

⁶⁸Lacan, *Écrits*, 54.

⁶⁹Of course, it must not be forgotten that an arc in Table Ω connects the first and last letters in sequences of length four (see Figure 6).

⁷⁰Lacan, *Écrits*, 42.

⁷¹Because a quadrant begins with two letters, the α and δ as well as the β and γ displacement patterns are arranged in the same order for each of their associated moieties. The sequences in these pairs of letters are essentially the same, varying only in the starting letter.

⁷²The algorithm for generating the displacement patterns in Figure 9 can be described as follows. At time one, write out a given moiety for a length 2^{n-1} times, with n being the desired length of the sequence (note: sequences are written in time from top to bottom). At time two, write out $n/2$ times the two possible outputs of the single moiety at time one. At time three, write out $n/4$ times the four outputs beneath the appropriate moieties at time two. Repeat this process, subdividing the previous moieties as above by writing out their two outputs, until no further subdivision is possible. At each time step t , color the moiety based on its quadrant location, defined, as spelled out in Appendix 1, by the first letter ($t=1$) and the last letter ($t=n$) in the sequence at that point. This process is illustrated with moieties written out in Figure 7. NB width of all figures generated using this algorithm are elongated for better visibility, as is the case with other figures coloring quadrant locations at a specific point in time.

⁷³As shown in Appendix 4, the patterns are made up of specific codes.

⁷⁴Whereas β and δ each comprise 0.25 of all letters in every quadrant (no matter the length of the sequence), after step four the frequency of α is greater than that of γ in Quadrant I, and γ is greater than that of α in Quadrant IV (see Appendix 3). For strings of length five the frequency of α in Quadrant I and of γ in Quadrant IV is 0.45, and this number slowly decreases over time, eventually converging to 0.25, this convergence due to the fractal properties of the patterns (that is as more and more smaller patterns emerge within the larger patterns over time).

⁷⁵For other examples of substitution systems, see Stephen Wolfram's *A New Kind of Science* (Champaign, IL: Wolfram Media, Inc., 2002). Pages 83 and 84 of that text provide illustrations of substitution systems that produce patterns similar to some of those in Figure 9. The similarities are due to the fact that Lacan's letter code (the moieties) and some of the substitution systems on pages 83 and 84 are essentially binary. For instance, in the Thue-Morse example, which is (b) on page 83, half the patterns switch colors at each time step. The patterns generated by the quadrant displacement patterns in Lacan's letter code are more elaborate, however, than those produced in the Thue-Morse example, involving, as the Lacanian letter code does, changes produced at a later point in time (not just the next time step) via the switching mechanisms of the eight moieties and the required agreement of the first and last letters in a given code with the coordinates defining the quadrants. Although interesting, it is not the intention of this paper to explore the fractal properties of Lacan's code in greater detail.

⁷⁶Freud, "Beyond the Pleasure Principle," *Standard Edition*, vol. XVIII, (London: Hogarth,

1926/1959) 1-64. For a brief discussion of the appropriateness of associating γ with the drives, see fn. 40.

⁷⁷Lacan, *The Seminar of Jacques Lacan Book XIX Ou Pire (1971-1972)*, trans. Cormac Gallagher, 1972, [10.5.72], <http://www.lacaninireland.com/web/wp-content/uploads/2010/06/Book-19-Ou-pire-Or-worse.pdf> (accessed 2017). Quoted as well in Adrian Johnston, *Žižek's Ontology: A Transcendental Materialist Theory of Subjectivity*, (Evanston, IL: Northwestern University Press, 2008) 224.

⁷⁸Connecting from *within* (in the case of γ_{12}) or from *without* (in the case of α_{12}) to the $\beta\beta\delta\delta$ structure, or its variant (see Appendix 2), that covers S (including the imaginary axis as shown most clearly in Appendix 5). Samples 3-4 in Appendix 4 illustrate these transitions into the imaginary axis via the suffixes listed in Appendix 3). Note: to cross from the symbolic node γ_{12} to the imaginary node α_{34} requires at the minimum the suffix $\delta_{34} \gamma_{34}$; similarly, to cross from α_{12} to γ_{34} requires at the minimum the suffix β_{12} and α_{34} , which is the inverse of the γ_{12} suffix. *Working out the other suffixes for α_{12} and γ_{12} produces the L Chain*, which connects the *within* of the subject to the *without* of the Other, as discussed at the end of Appendix 2.

⁷⁹John Johnston, *The Allure of Machinic Life: Cybernetics, Artificial Life, and the New AI* (Cambridge, MA: The MIT Press, 2008).

⁸⁰Lacan discusses this machine in Seminar II. Built in the early 1950s, SEER is the SEquence Extraction Robot that was designed to play the game of Even and Odd. This machine was built at Bell Telephone Laboratories by D. W. Hagelbarger (a simpler version was constructed by Claude Shannon). SEER exploited the human tendency to generate nonrandom patterns as a function of emotions and previous experience. Equipped with a tiny memory that kept track of three items of information (the machine's results for the last two moves, recorded simply as a win or a loss, and whether the player played the same or different), SEER was designed to select a correlated output when winning and a random output when losing. For more information about SEER, see, D. W. Hagelbarger, "Seer, a Sequence Extraction Robot." *IRE Transactions on Electronic Computers* 5. March (1956). For an account of Lacan's commentaries on SEER, see Annette Bitsch, "Kybernetik Des Unbewusstens," *Cybernetics - Kybernetik* 2 (2011): 157-58. See also, Bernard Dionysius Geoghegan, "From Information Theory to French Theory: Jakobson, Lévi-Strauss, and the Cybernetic Apparatus," *Critical Inquiry* 38 (2011): 96-126.

⁸¹Élisabeth Roudinesco, *Jacques Lacan & Co.: A History of Psychoanalysis in France 1925-1985*, trans. Mehlman, Jeffrey (Chicago: The University of Chicago Press, 2014 [2011]).

⁸²Jean-Pierre Dupuy, *The Mechanization of the Mind: the Origin of Cognitive Science*, trans. DeBevoise, M. B. (Princeton, NJ: Princeton University Press, 2000 [1994]) 108.

⁸³Lacan, *Sem. II*, 306.

⁸⁴Johnston, *The Allure of Machinic Life*, 79-80.

⁸⁵Johnston, *The Allure of Machinic Life*, 80.

⁸⁶Lacan, *Sem. II*, 47.

⁸⁷Johnston, *The Allure of Machinic Life*, 86.

⁸⁸Lacan, *Sem. II*, 40-41.

⁸⁹Lacan, *Sem. II*, 43.

⁹⁰Both functions involve grouping and are a primitive form of counting. Oddness is the recognition that when objects are lined up into two rows, something sticks out; there is too much or too little. Evolutionarily, it may be the case that before human beings were able to count, they were able to divide objects into equivalent ratios. Some animals and birds are known to be capable of discerning the relative size of small groups of items, with rhesus monkeys, for instance, being able to match the number of sounds they hear to the number of shapes they see. (see Dustin J. Merritt, Rosa Rugani, and Elizabeth M. Brannon. "Empty Sets as Part of the Numerical Continuum: Conceptual Precursors to the Zero Concept in Rhesus Monkeys," *Journal of Experimental Psychology: General* 138.2 (2009): 258-69). Though probably unable to count, Rhesus monkeys appear to be able to do an estimation of the size of sets of objects (see Caroline B. Drucker, Marley A. Rossa, and Elizabeth M. Brannon. "Comparison of Discrete Ratios by Rhesus Macaques (*Macaca Mulatta*)," *Animal Cognition* 19 (2016): 75-89). I have not come across studies showing animals able to distribute objects evenly into groups, though some birds and fish appear to divide territories into patches according to a ratio of profitability. See C. R. Gallistel, *Organization of Learning* (Cambridge: MIT Press, 1990). It is possible that ratio discrimination evolved with human beings into the social acts of sharing and gift exchanging.

⁹¹"I also said that we have, of course, to take the formal side of nature into account, in the sense in which I qualified it as possessing pseudo-significant symmetry, because that is what man embraces in order to produce his fundamental symbols. The important thing is what gives the forms of nature symbolic value and function, what makes them function in relation to one another. It is man who introduces the notion of asymmetry. Asymmetry in nature is neither symmetrical, nor asymmetrical—it is what it is." Lacan, *Sem. II*, 38.

⁹²See note 91.

⁹³"I am explaining to you that it is in as much as he is committed to a play of symbols, to a symbolic world, that man is a decentred subject. Well, it is with this same play, this same world, that the machine is built. The most complicated machines are made only with words." Lacan, *Sem. II*, 47.

⁹⁴Lacan, *Écrits*, 10.

⁹⁵Lacan, *Sem. II*, 192.

⁹⁶Lacan, *Sem. II*, 194. Also, as Lacan informs the analyst, "Last time I told you that symbolism is essential to all the most basic manifestations of the analytic domain, namely to repetition, and that we must think of it as tied to a circular process of the exchange of speech. There is a symbolic circuit external to the subject, tied to a certain group of supports, of human agents, in which the subject, the small circle which is called his destiny, is indeterminately included," (98).

⁹⁷Lacan, *Écrits*, 4.

⁹⁸Lacan, *Sem. II*, 196.

⁹⁹Lacan, *Écrits*, 196.

¹⁰⁰Lacan, *Écrits*, 197.

¹⁰¹Lacan, *Écrits*, 89-90.

¹⁰²This information is evident in a careful inspection of Lacan's Tables Ω and O , as the additional labels in Figure 6 make explicit.

¹⁰³Lacan, *Écrits*, 50. Of course, Lacan may be referring here to the patterns of absence observable only at time four; but, as I have shown, this pattern is an anomaly of a more general pattern of absence caused by the bounding moieties. Interestingly, Lacan notes in footnote 25 that the *caput mortuum* is 7/16 if letter order is not taken into consideration—though he may be calculating this ratio on each table (Ω and O), this number requires the interconnection of *two* quadrants.

¹⁰⁴Let me stress here that codes of any length greater than three are chains of moieties connected by their inputs and outputs. After time three strings that begin with α and δ , for instance, end not only with the letters α and β but also with γ and δ because category 1 moieties are able to link up with both category 1 and 0 moieties, forming the patterns [*start category, end category*]: [1,1] and [1,0]. Likewise, strings beginning with category 0 inputs (β and γ) are able to link up with moieties belonging to both category 0 and 1 moieties, producing the delimiters [0,0] and [0,1]. These are the very combinations of categories in the second and penultimate positions of four-letter strings that originally define the quadrants and that produce the patterns of retroactive dematerializations of letters that Lacan highlights in his Tables Ω and O —dematerializations that manifest again whenever strings of any length are halted (see Table 2 and the trees in Figure A1.3). Moreover, as demonstrated in the text, at time five, pairs of quadrants are breached and become interconnected thereafter. At this moment yet another gap emerges that separates (most importantly, considering the L schema) strings that start with α from those that begin with γ . Thus it is that Lacan's computational model demonstrates for us not only how early primitive symbolic formations persist beneath the surface (as illustrated in Freud's *Wunderblock*) but also how such formations continuously propagate and evolve into ever more complex formulations (see fns. 27, 40, 57, and 117).

¹⁰⁵Lacan, *Écrits*, 54.

¹⁰⁶The only connection allowable after $\beta\delta$ that connects back to another β is $\delta 12$ to $\beta 12$ or $\gamma 34$ to $\beta 34$. In other words, an expansion of the quotes as specified by Lacan requires the insertion of γ before connecting back to β .

¹⁰⁷See Appendix 2 in Bruce Fink, *The Lacanian Subject: Between Language and Jouissance* (Princeton, NJ: Princeton University Press, 1995).

¹⁰⁸As mentioned above in fn. 106, I add this to make the expression legal according to the rules of the Greek letter encoding scheme.

¹⁰⁹See Appendix 5 for a discussion of $\alpha 12$ as the end node of the L Chain language.

¹¹⁰Lacan, *Écrits*, 55.

¹¹¹Lacan, *Écrits*, 55.

¹¹²Lacan, *Écrits*, 56.

¹¹³Fink, *The Lacanian Subject*, 171.

¹¹⁴Lacan, *Écrits*, 57.

¹¹⁵Very few pure strings contain no $\alpha 12$ or $\gamma 12$ roots. After length five, when displacements occur, $\alpha 12$ and $\gamma 12$ form the heart of all pure codes. For strings of length five, however, half the pure codes for quadrants II and III contain no $\alpha 12$ or $\gamma 12$ roots.

¹¹⁶For more details on pure codes as they relate to quadrants and specific starting moieties, see fn. 60.

¹¹⁷This is an emergent property of the two-sidedness of the letters, which produces at time four with the four-letter sequences the quadrants that continuously perpetuate the binary split that extends as far back as the original plus and minus inscription of presence and absence that was simulated by flipping a coin. I discuss this split and its connection to the Oedipus complex at time five with the five-letter codes in *On Lacan's Neglected Computational Model and the Oedipal Structure: An Expanded Introduction* to "Primordia of Après-Coup, Fractal Memory, and Hidden Letters: Working the Exercises in Lacan's Seminar on The Purloined Letter" located in this issue of S; 261-274.

¹¹⁸Lacan, *Écrits*, 56 (see also the note in fn. 78).

¹¹⁹Lacan, *Écrits*, fn. [28] 61.

¹²⁰The transition diagram is diachronic in that it reveals (in tandem with Figure 3) the number codes informing the letter codes.

¹²¹As Lacan states, "the redoubled parenthesis [$\beta\beta\delta\delta$] is fundamental," Lacan, *Écrits*, 54.

¹²²In contrast to γ_{12} , which is entered into before the $\beta\beta\delta\delta$ basic structure can be completed. See as well fn. 125.

¹²³Lacan, *Écrits*, 42.

¹²⁴Lacan, *Écrits*, 42.

¹²⁵Consider as well the composites of α and γ on the bottom row of Figure 3: γ inscribes the cycle *inside* the larger circuit and α inscribes the 11^+ and 33^+ self-loops *outside* the larger circuit. It is by virtue of being the alpha and omega that α_{12} intermixes subjectivities in that it connects one $\beta\beta\text{-}\delta\delta$ structure covering a subject to another (see discussion at end of Appendix 2).